



UCIRVINE

THE HENRY SAMUELI
SCHOOL OF ENGINEERING

Mechanisms Underpinning Degradation of Protective Oxides and Thermal Barrier Coatings in High Hydrogen Content (HHC) – Fueled Turbines

Daniel R. Mumm

Chemical Engineering and Materials Science
Advanced Power and Energy Program (APEP)
University of California, Irvine
Tel: (949) 824-3858; Fax: (949) 824-2541
mumm@uci.edu

2012 University Turbine Systems Research Workshop
Irvine, CA; October 2nd – 4th, 2012

U.S. Department of Energy; National Energy Technology Laboratory
Agreement # DE-FE0004727; Project Manager: Dr. Patcharin Burke



U.S. DEPARTMENT OF
ENERGY

Introduction

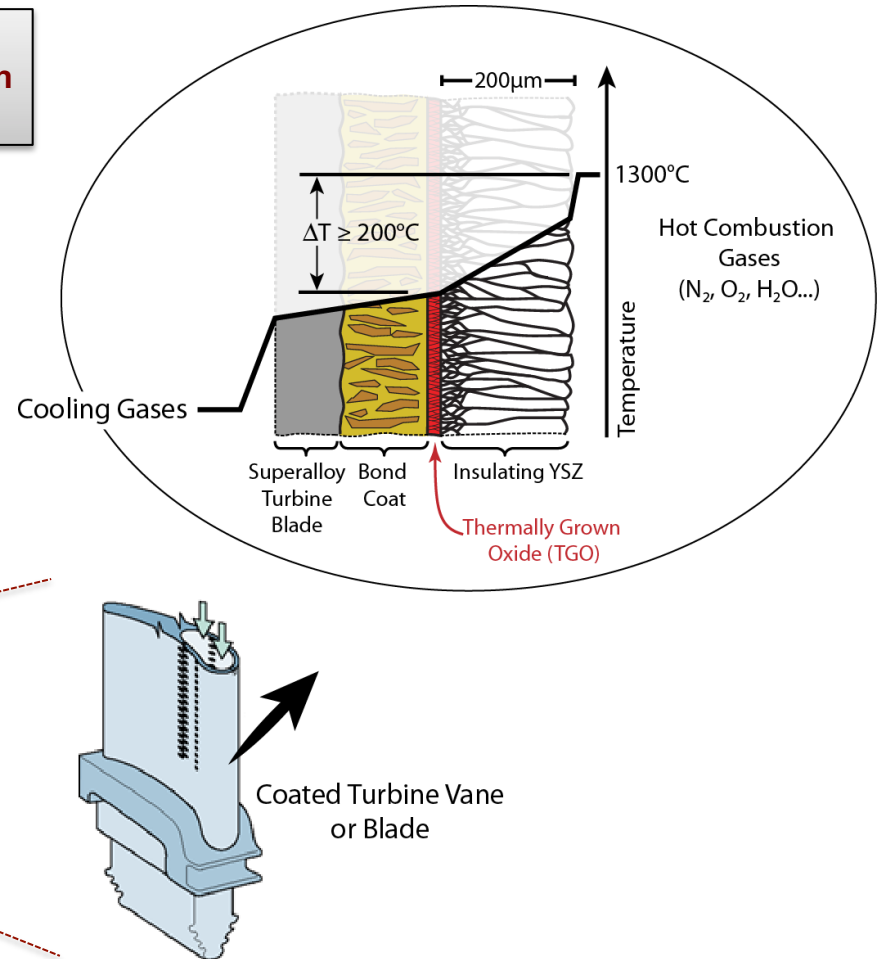
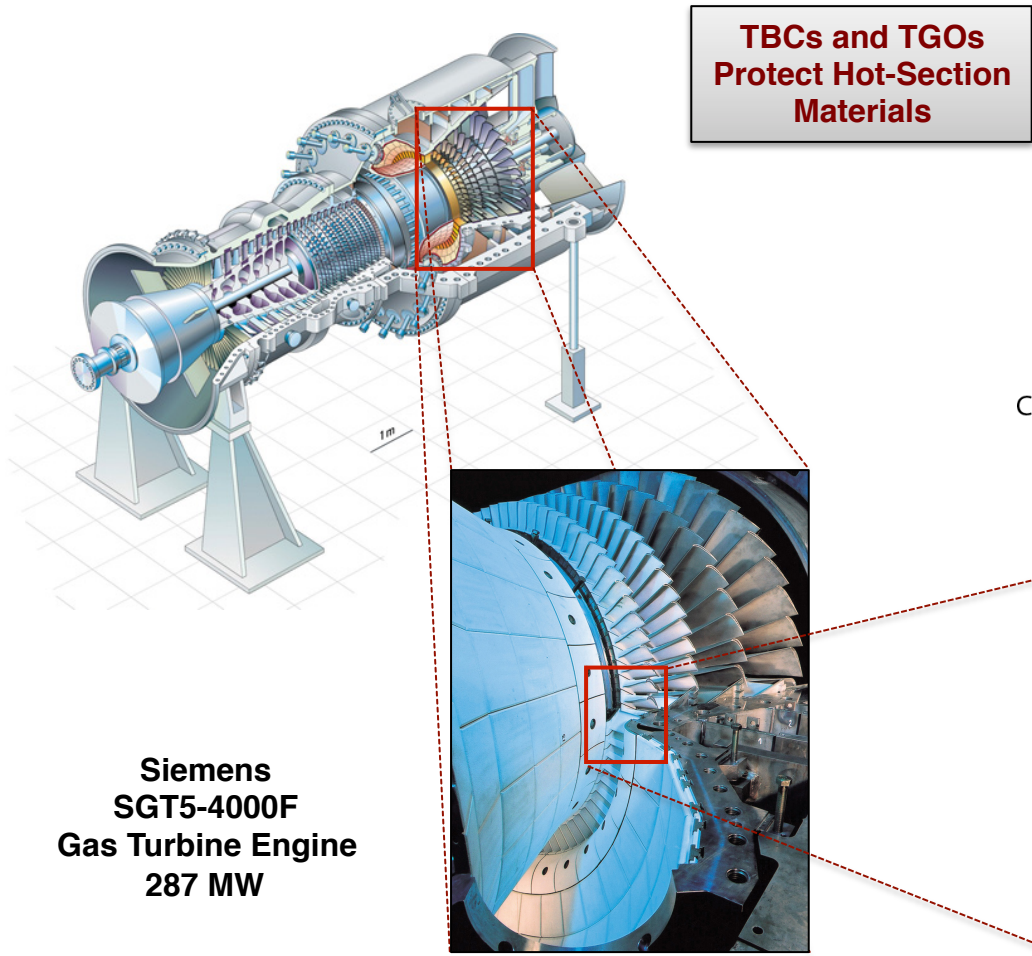

Thermally Grown Oxides and TBCs

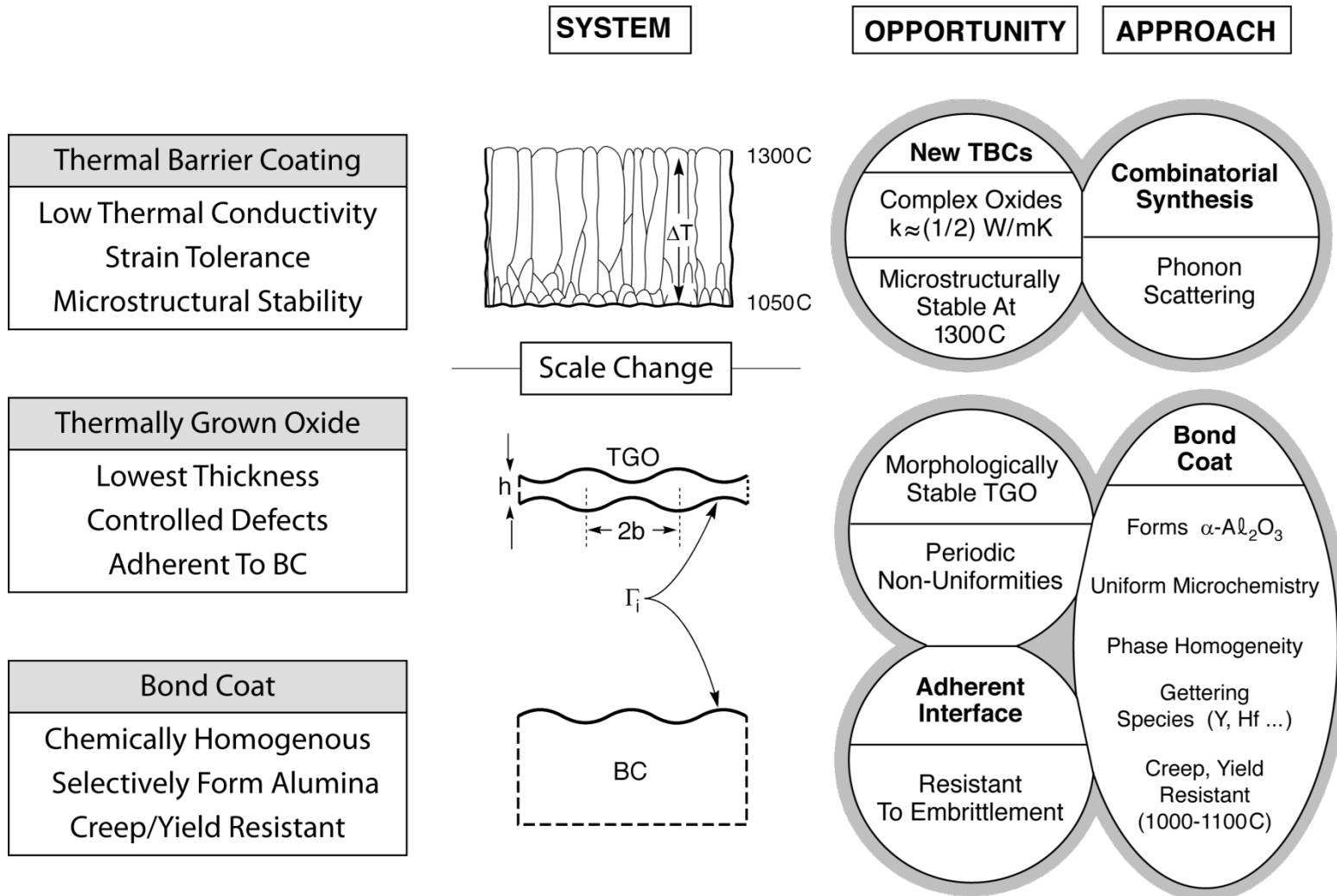

Potential Challenges in Transitioning to Alternative Fuels

A.G. Evans (2007)

How is this behavior modified with adoption of alternative fuels or blends?

How prevalent are these damage mechanisms for power generation turbine systems in association with HHC fuels?

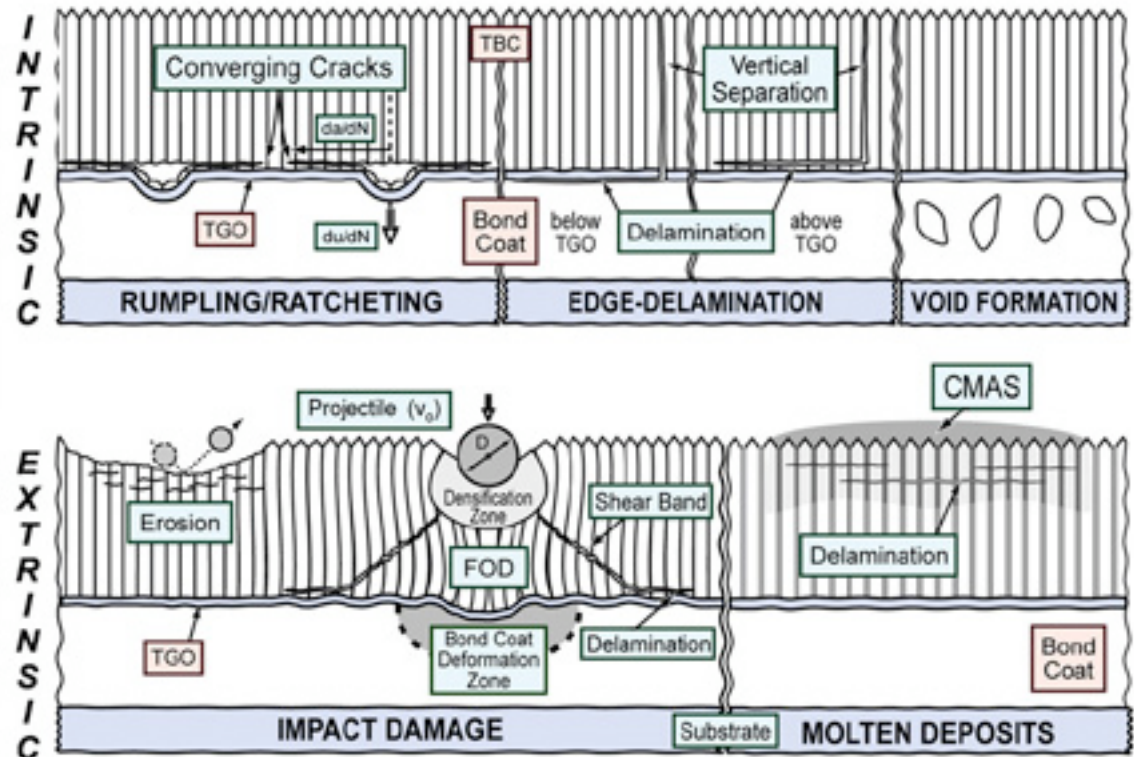

A.G. Evans, D.R. Clarke and C.G. Levi (2008)
Journal of the European Ceramic Society, 28, 1405-1419.

A.G. Evans, D.R. Mumm, J.W. Hutchinson, G. Meier and F.S. Pettit (2001)
Progress in Materials Science, 46, 505-53.



Deposit Formation and Infiltration

A.G. Evans (2007)

Deposit Formation

What potential analogies to CMAS degradation arise with use of syngas or HHC fuels and intrinsic combustion by products ?

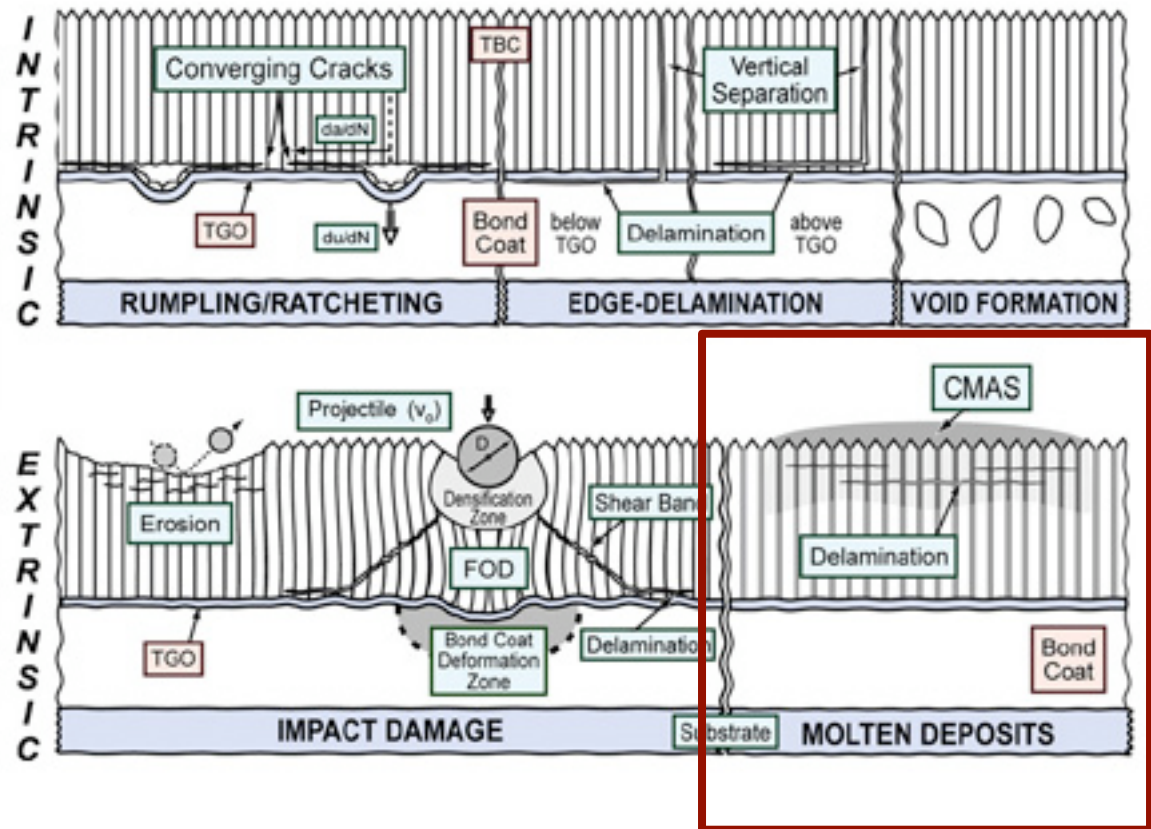

Project Motivation: Non-Ideal TGO Growth

Natural Gas

Bond Coat Type 1

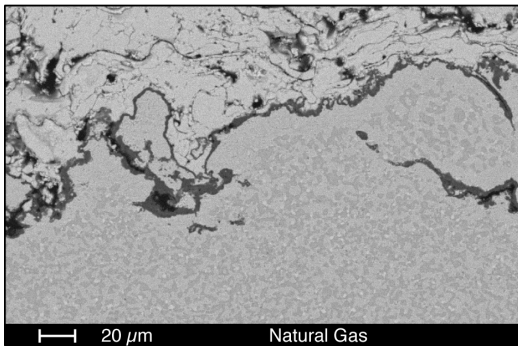

Bond Coat Type 2

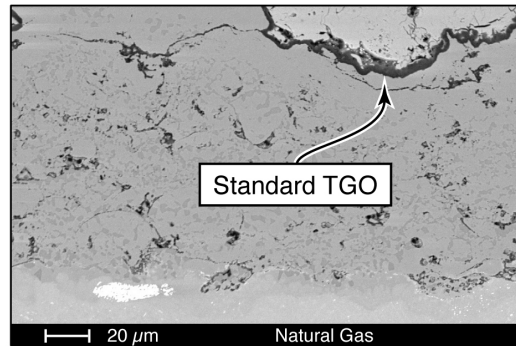

Syngas Blend

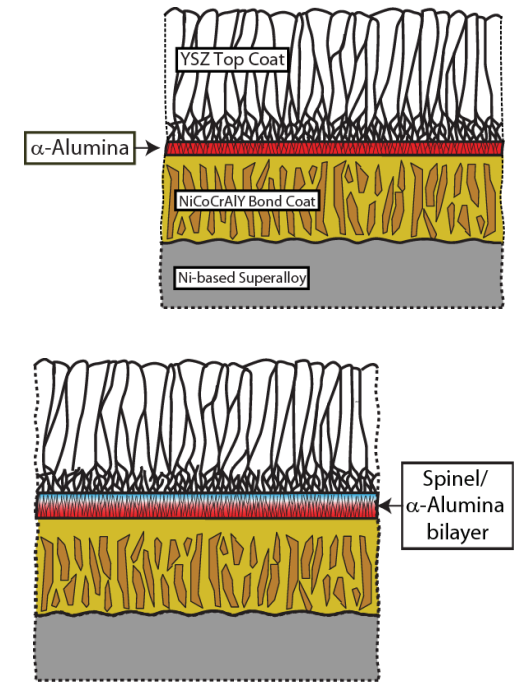
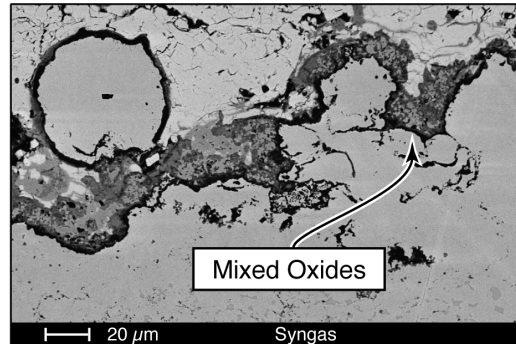
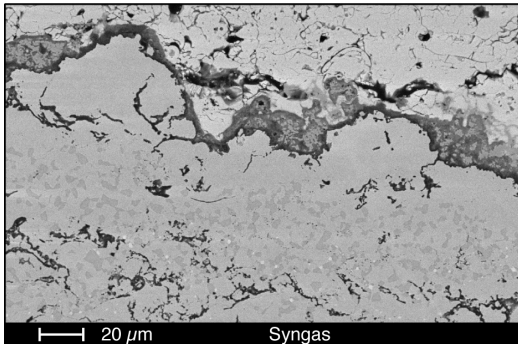

- ✧ Note location of new (spinel) phases – above the alumina
- ✧ Requires Ni transport **through** the alumina layer...



Non-Ideal Oxide Formation: Thermo-Mechanical Implications

So why are we concerned with external spinel formation?

Spinel Formation in Plasma Sprayed TBCs Preferential Crack Propagation Pathways

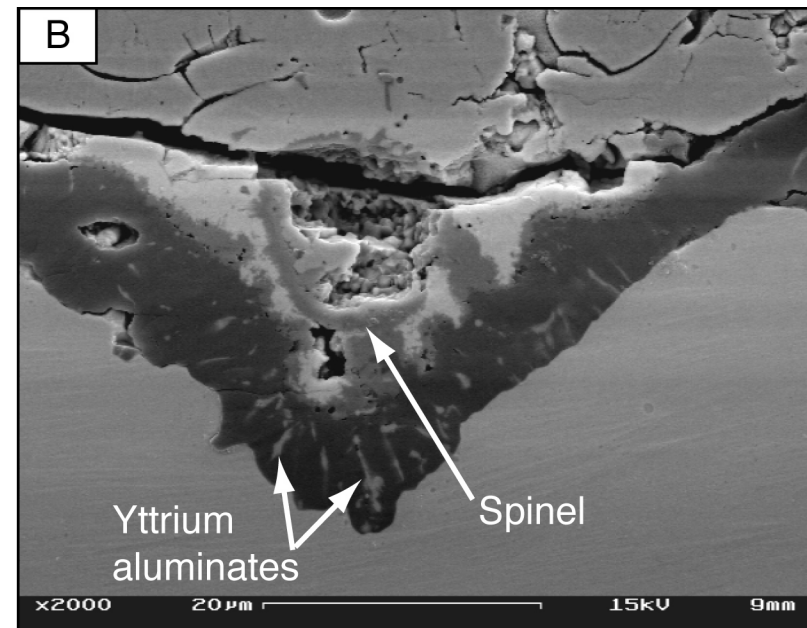
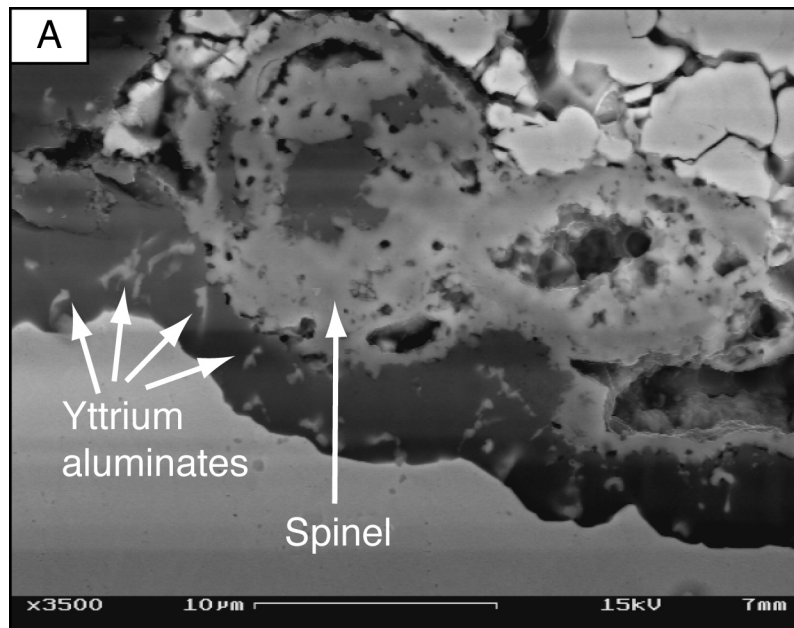

A. Rabiei and A.G. Evans (2000), *Acta Materialia*, 48, 3963-76.



TGO growth Mechanisms and Effects of Combustion Environment

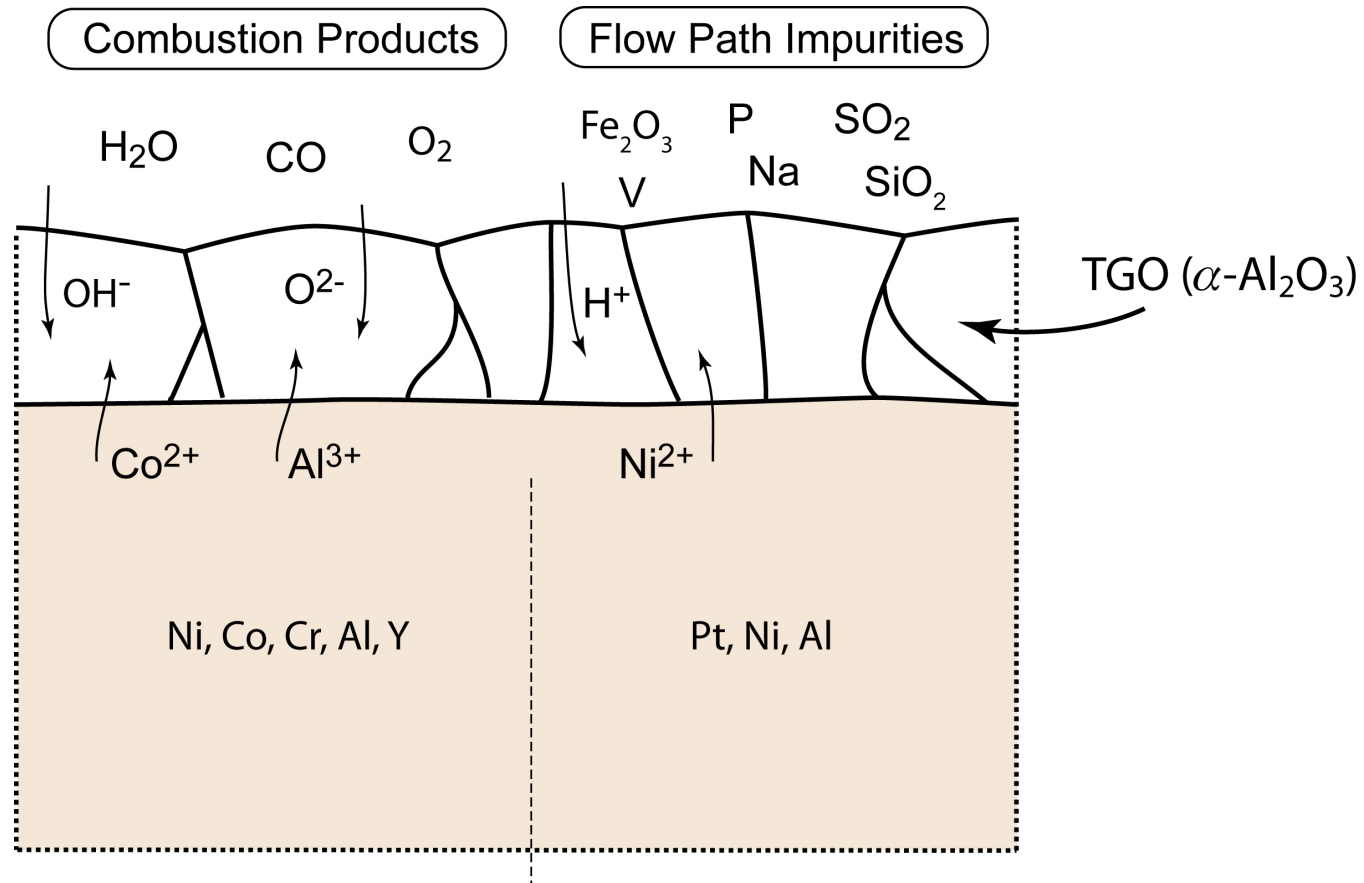

TGO Development Studies: Non-Ideal Growth Mechanisms

Observed spinel formation not simply due to depletion of Al....

TGO (α -Al₂O₃) Cracking

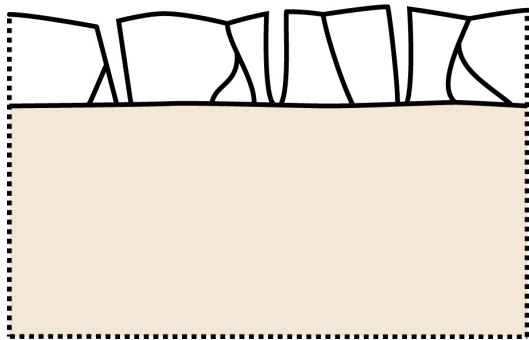

NiO Formation

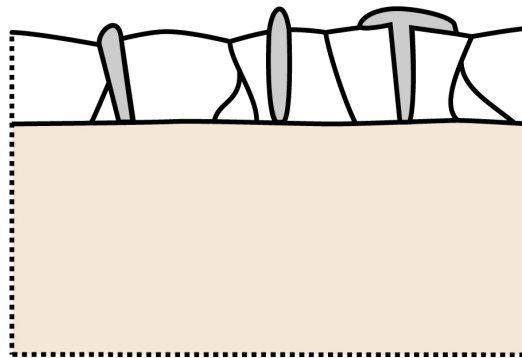

Conversion to NiAl₂O₄

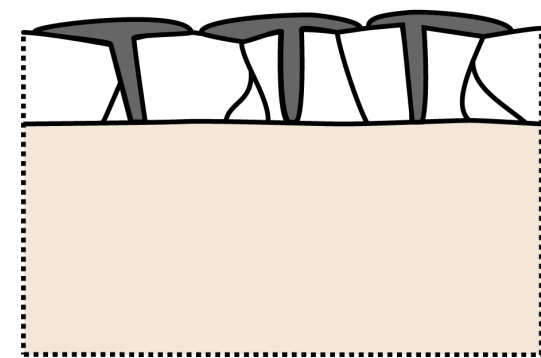

Schematic describes an accepted mechanisms for formation of spinel through NiO intermediate phases

Microstructural features inconsistent with behavior observed in previous isothermal experiments



Implications of Proposed Mechanisms – Mitigation Strategies

❑ **Spinel Formation Dominated by Short-Circuit Pathways**

Materials design strategies focus on preventing aluminum depletion in bond coat and preferential formation of NiO in cracks and 'open' diffusion paths.

❑ **Spinel Formation Dominated by Mechanisms Allowing Ni GB Diffusion**

Materials design strategies focus on mechanisms affecting GB transport, along lines of RE doping additions.

❑ **Spinel Formation Dominated by Ni activity in growing TGO**

Materials design strategies focus on changing defect chemistry to limit solubility and potential for reaching critical activity necessary for new phase formation.



Project Motivation: Enhanced TBC Degradation

TBC Sintering and Phase Destabilization

Does HHC/syngas combustion environment lead to enhanced sintering and destabilization of thermal barrier top coats?

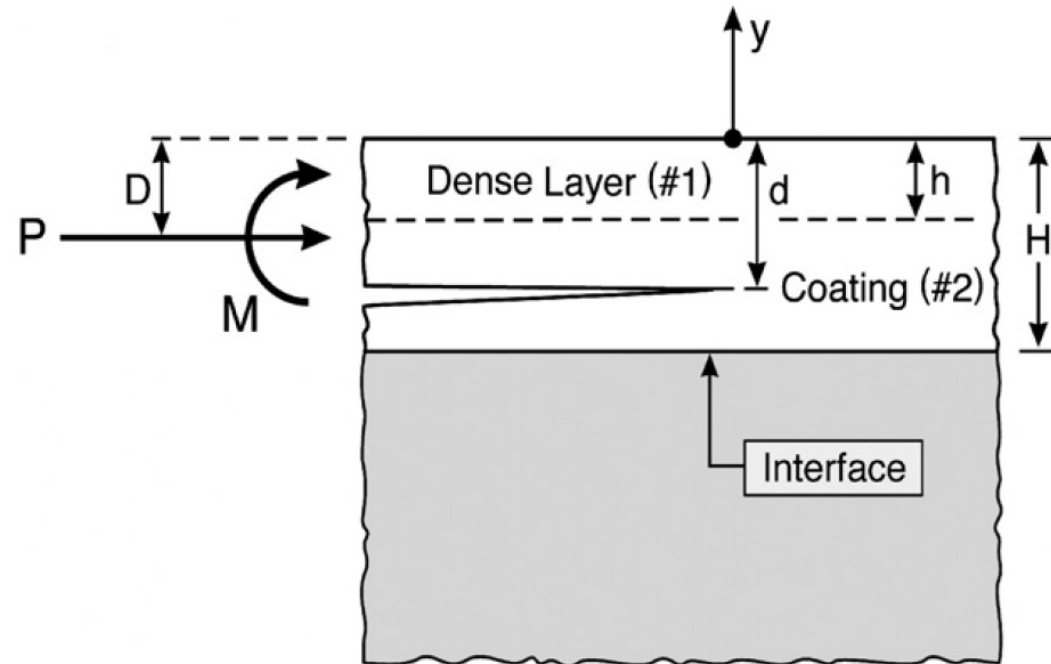

Project Motivation: Deposit-Induced Failure

What is the potential for CMAS-based failure in HHC/syngas environments?

What are the characteristic chemistries of deposits and the associated thermo-physical and thermo-chemical properties and thermo-mechanical failure mechanisms?

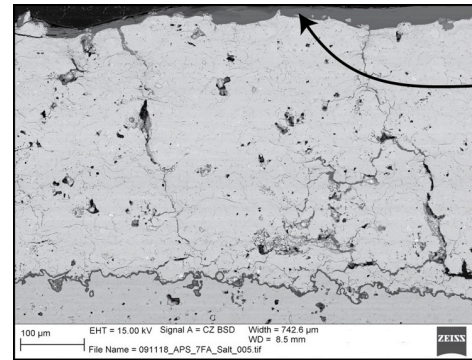

Surface Deposit Layer

LPPS NiCoCrAlY BC
DVC Top Coat

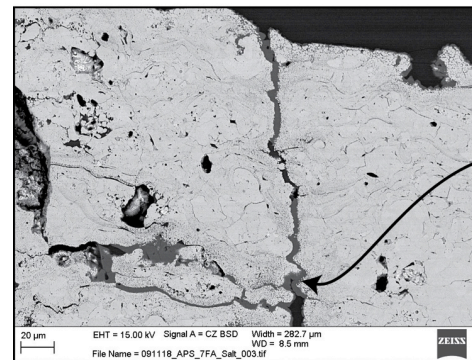

Molten Phase Intrusion

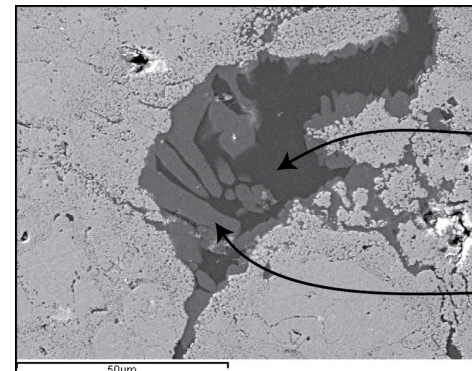

Amorphous glass phase

Re-precipitated ZrO_2



Current Discussion

Assessment of the stability of current hot-section materials in emerging HHC/syngas fueled turbine systems.

Non-Ideal oxide formation and water-vapor effects on TGO development

TBC stability studies in high $p\text{H}_2\text{O}$ environments

Characteristic surface deposits and CMAS-based degradation

New materials and processing approaches directed at mitigating damage evolution.



Project Overview: Goals and Objectives

- Derive a **mechanisms-based understanding** of protective TGO layer and TBC system degradation associated with turbine operation with syngas and high hydrogen content fuels, and develop a knowledge base upon which design of coatings more resistant to the observed attack mechanisms may be based.
 - Link and quantify the effects of higher water vapor content, modified combustion gas composition, higher sulfur concentrations, and exposure to flow stream impurities characteristic of syngas and HHC fuels on hot section materials stability.
 - Identify any synergism among these factors influencing materials stability.
 - Investigate novel materials solutions to mitigate materials degradation.
 - Educate the next generation of scientists and engineers trained in materials design for advanced turbine systems.



Project Scope

- ❑ **Project has an overarching goal of attaining a stable, durable TBC system for use in coal-derived syngas and HHC environments.**
- ❑ To achieve this goal, the project is organized around six inter-related themes:
 - ★ Evaluating the role of HHC combustion in modifying hot-section component surface temperatures, heat transfer, and resulting thermal gradients within the TBC coatings.
 - ★ Understanding the instability of TBC coatings in syngas and high hydrogen environments, with regards to decomposition, phase change and sintering.
 - ★ Characterizing ash deposition, molten phase development and infiltration, and associated corrosive / thermo-chemical attack mechanisms.
 - ★ Developing a mechanics-based analysis of driving forces for crack growth and delamination, based on molten phase infiltration, misfit upon cooling, and loss of compliance
 - ★ Understanding changes in thermally grown oxide (TGO) development associated with these emerging combustion product streams
 - ★ Identifying degradation resistant alternative materials for use in mitigating the observed degradation modes.



Approach: Alternative Fuel Effects and Synergistic Effects with Ash

- ❑ **Controlled isothermal exposures to simulated combustion gases**
 - Varying partial pressures of combustion products
 - Varying water vapor contents

- ❑ **Extended thermal exposures with ash constituents**
 - Exploration of molten phase formation, composition, and infiltration
 - Exposure to relevant impurities
 - Synergistic effects of water vapor content

- ❑ **Low velocity, low pressure burner rig testing**
 - Evaluation of deposit formation
 - Seeding with impurities, additives, etc

- ❑ **Examination of hardware removed from field service**
 - Compare and contrast power system hardware tested under Traditional and syngas/HHC combustion environments



Project Overview: Scope of Work

The scope of work was developed such that:

- The suitability of 'baseline' hot-section materials for use with syngas and HHC fueled turbines could be critically assessed.
- The mechanisms underpinning syngas and HHC fuel specific effects could be elucidated – and used as the basis for developing materials design protocols for improved materials.
- Within the time constraints of extended test protocols (accelerated, but $\geq 1000\text{hr}$), meaningful comparisons can be made between new/alternative materials and baseline systems through focusing on underlying mechanisms.

The project is responsive to overall program goals in that:

- The effort is aligned with maximizing system lifetime under increasingly harsh conditions and avoiding premature maintenance.
- Allowing for the extension of operational conditions to more aggressive regimes (higher temperatures, etc.)



TGO Development Studies: Explore Elevated pH₂O Effects

- ❑ Schematic Thermodynamic Stability Diagram – Ni-Al-O system
- ❑ Boundaries represent various equilibrium reactions

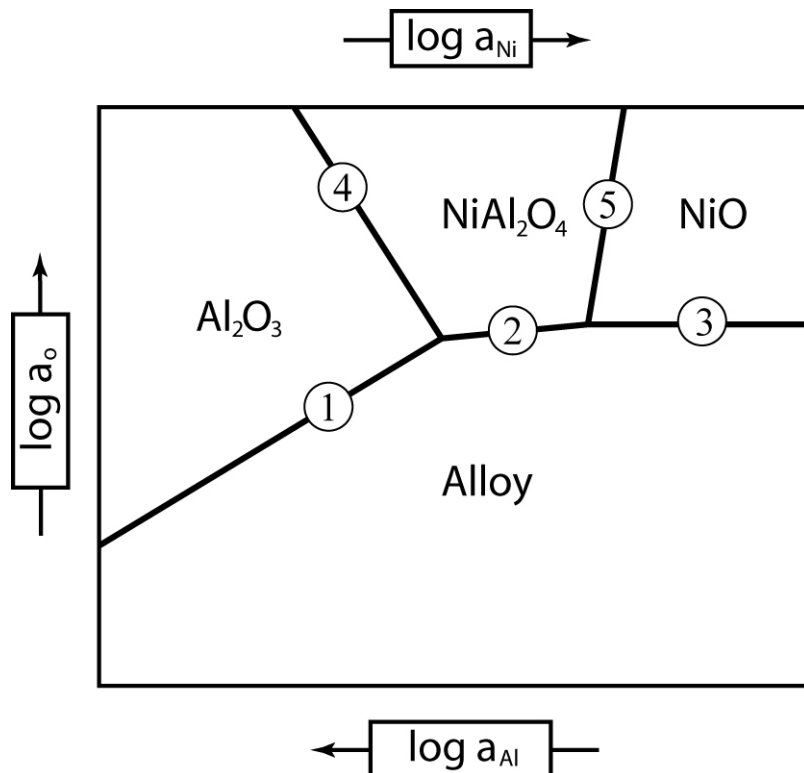

- ① $2Al + 3O \rightleftharpoons Al_2O_3$
- ② $Ni + 2Al + 4O \rightleftharpoons NiAl_2O_4$
- ③ $Ni + O \rightleftharpoons NiO$
- ④ $Al_2O_3 + 3Ni \rightleftharpoons 3NiAl_2O_4 + 2Al$
- ⑤ $NiAl_2O_4 + 3Ni \rightleftharpoons 4NiO + 2Al$

M.J. Stiger, N.M. Yanar, M.G. Topping, F.S. Pettit and G.H. Meier (1999)
Zeitschrift für Metallkunde, 90 [12], 1069-1078.

A.G. Evans, D.R. Mumm, J.W. Hutchinson, G. Meier and F.S. Pettit (2001)
Progress in Materials Science, 46, 505-53.



TGO Development Studies: Explore Elevated p_{H_2O} Effects

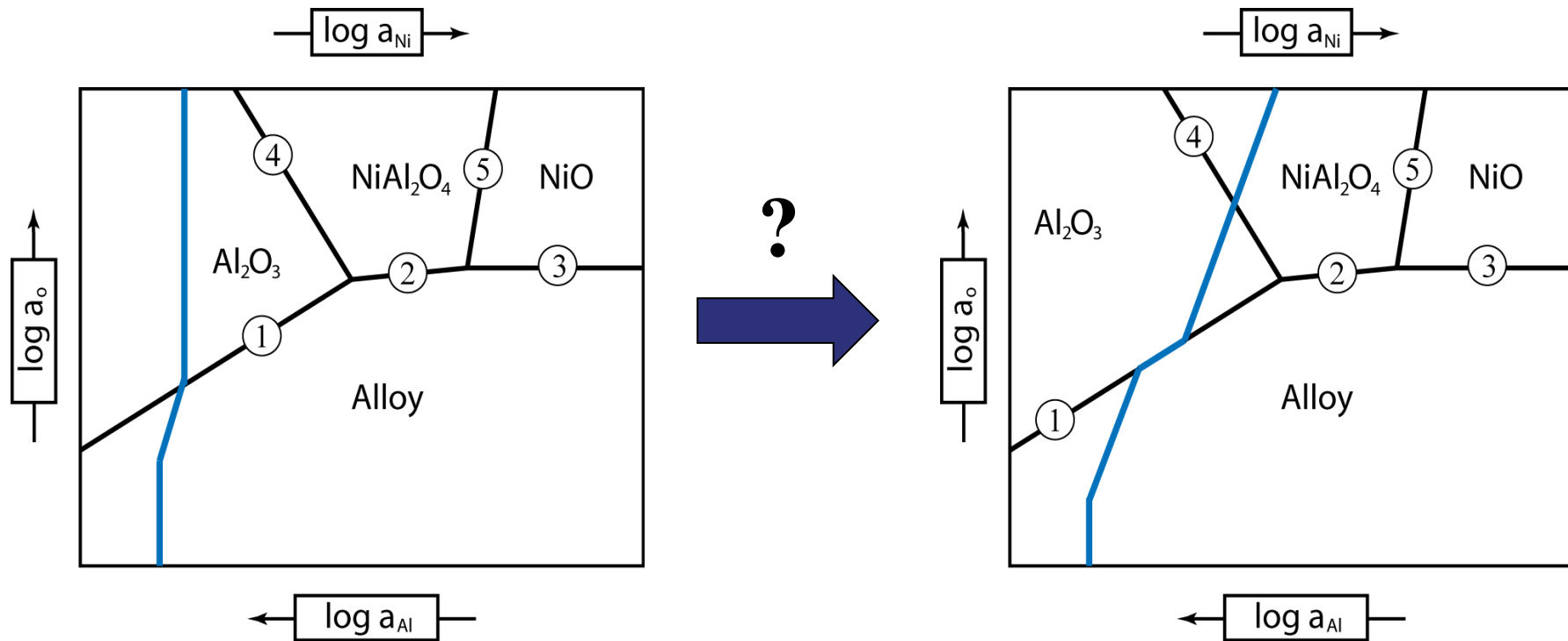

- ❑ Modification of the combustion environment alters reaction kinetics
- ❑ Dependence on partial pressures of gas stream constituents



TGO Development Studies: Explore Elevated pH₂O Effects

Isothermal oxidation at 1125°C in variable vol% H₂O environment

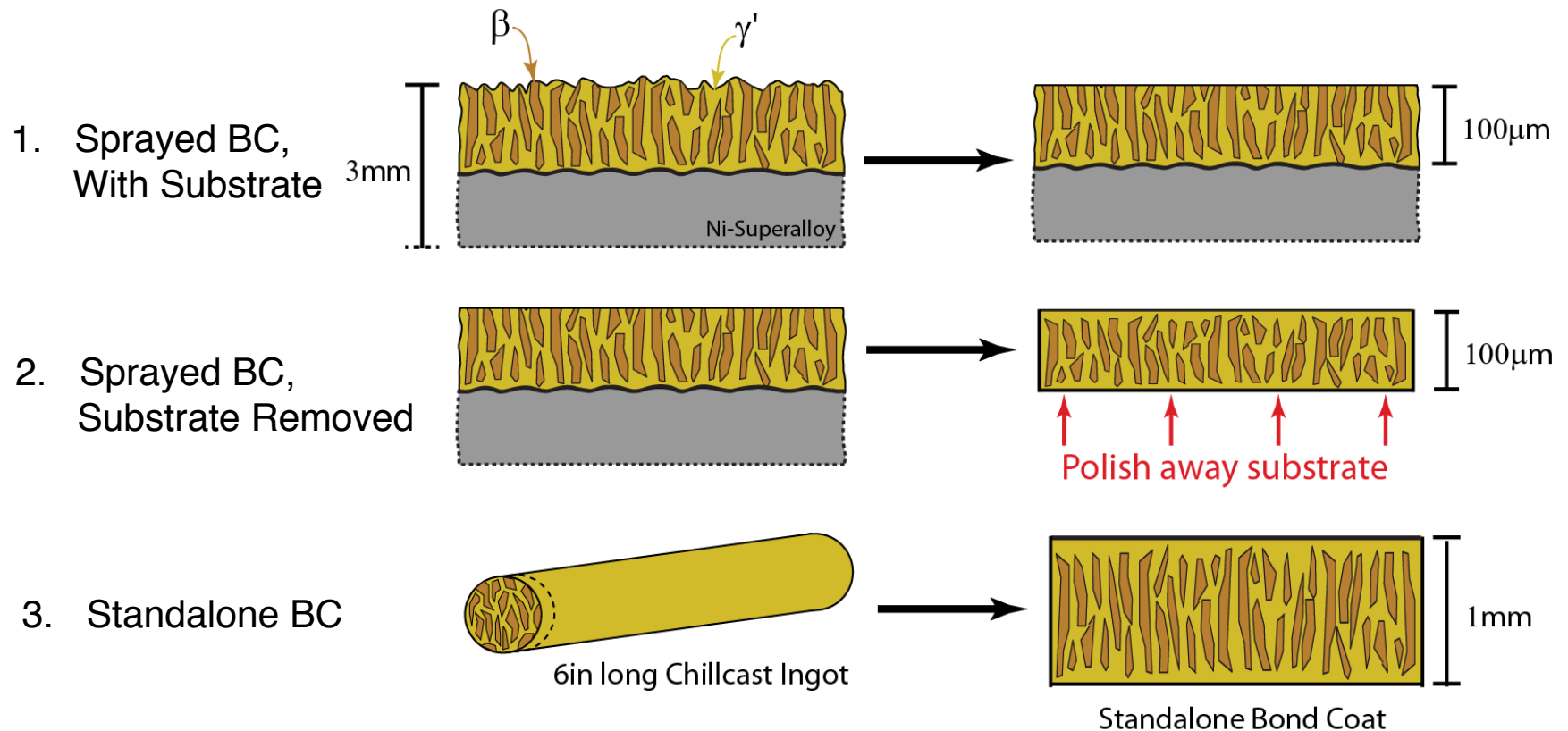

Methods

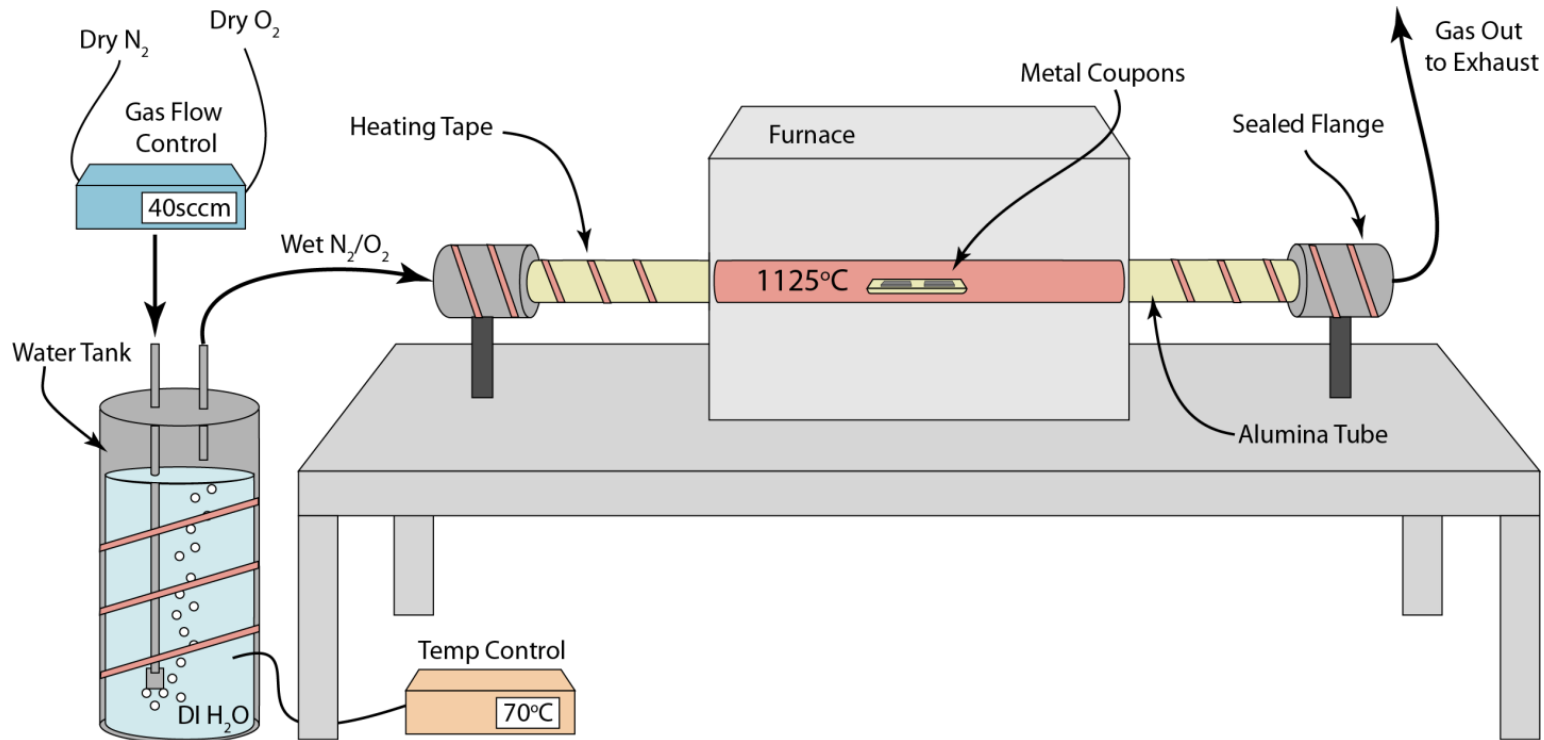

- Water tank temperature determines vol% H₂O via gas-liquid equilibrium exchange
- For 0% H₂O, the water tank is bypassed completely



TGO Development Studies: Tapered Specimen Studies

- I. Grow an initial oxide layer via isothermal exposure @ 1125°C
- II. Polish at a slight angle to create linearly variable diffusion lengths along the wedge
- III. Re-oxidize the sample to grow new oxide

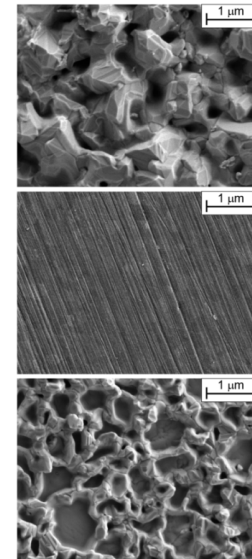
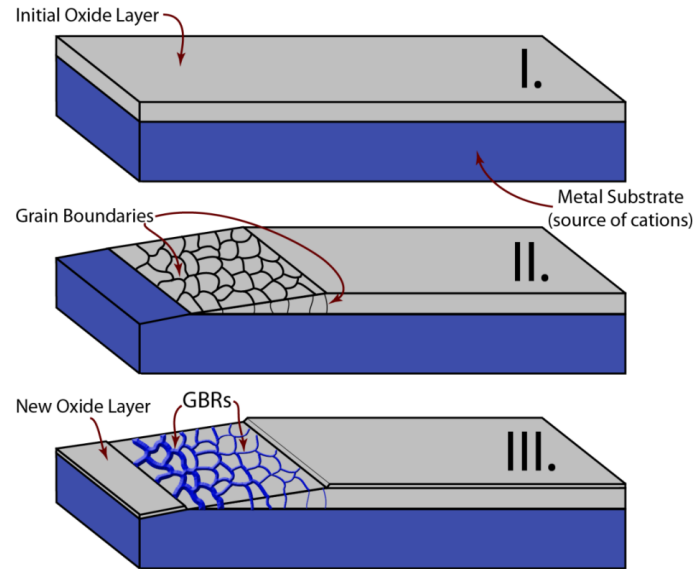

Examples from FeCrAlY

Original Wedge Geometry

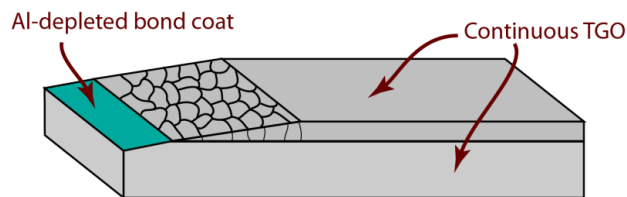

Modified Wedge Geometry

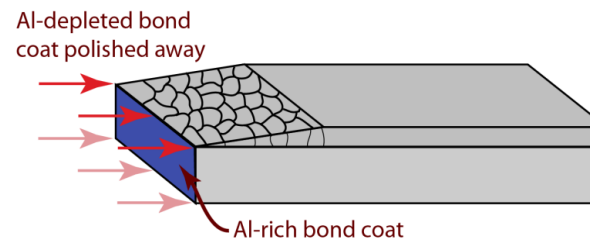

TGO Development Studies: Tapered Specimen Studies

Plan view images ▶

- 0% H₂O sample shows smooth, equiaxed α -alumina grains at surface, with cubic spinel grains scattered on top
- 15 and 30% H₂O samples show that the surface is completely covered with cubic spinel phase

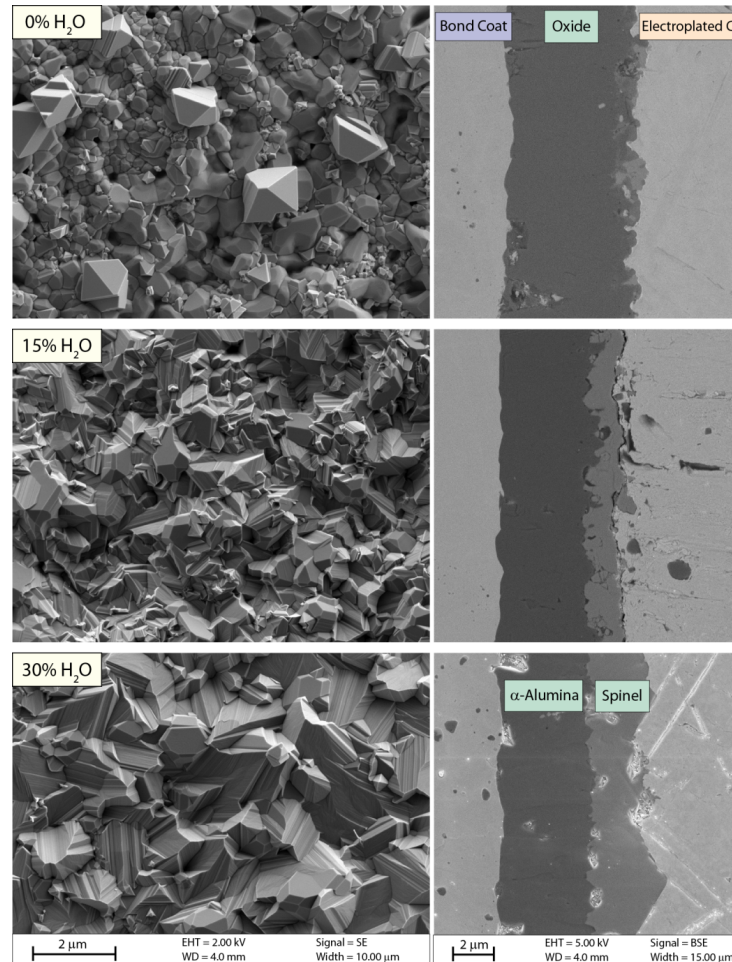

◀ Cross-Section images

- Overall TGO thickness stays virtually the same at all %H₂O
- Spinel top layer is continuous, gets thicker with increasing %H₂O



TGO Development Studies: Tapered Specimen Studies

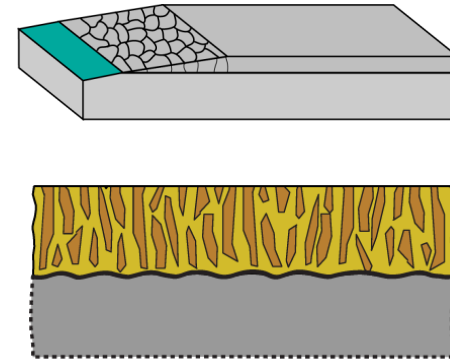
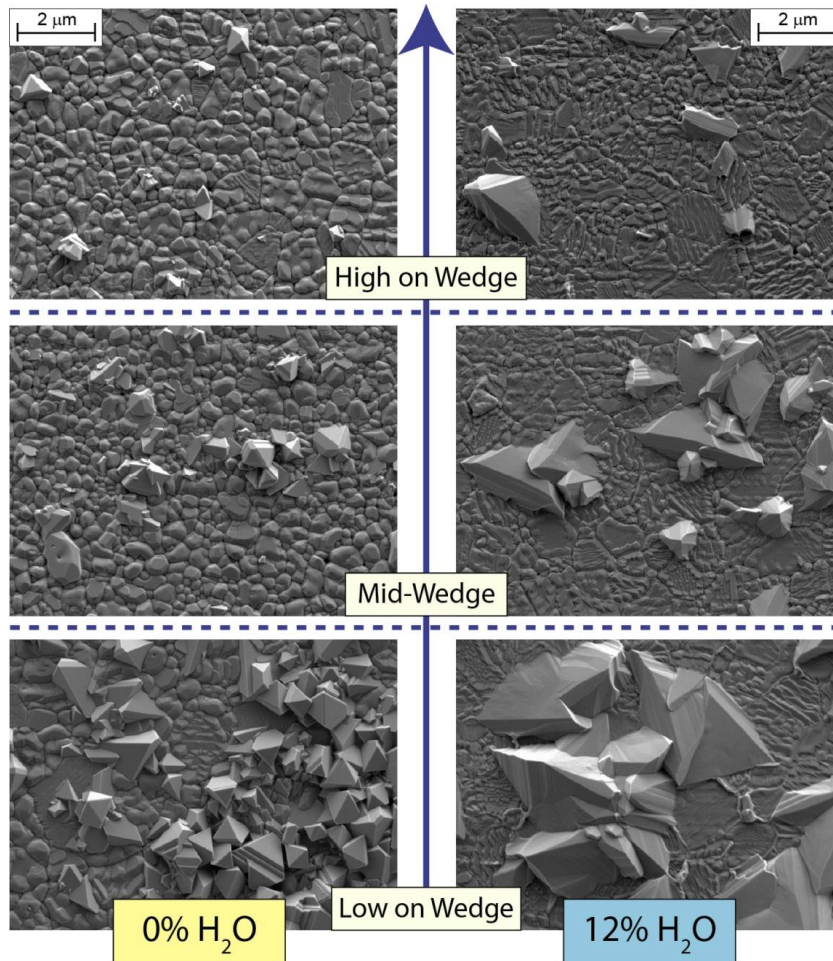

- ◀ After polishing and re-oxidation, spinel grains grow above the alumina wedge; grains are larger at the bottom where diffusion lengths through alumina are shortest
 - Water vapor promotes spinel growth at all wedge positions



TGO Development Studies: Tapered Specimen Studies

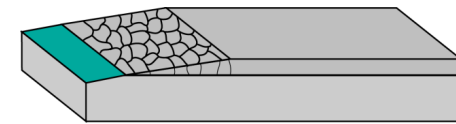
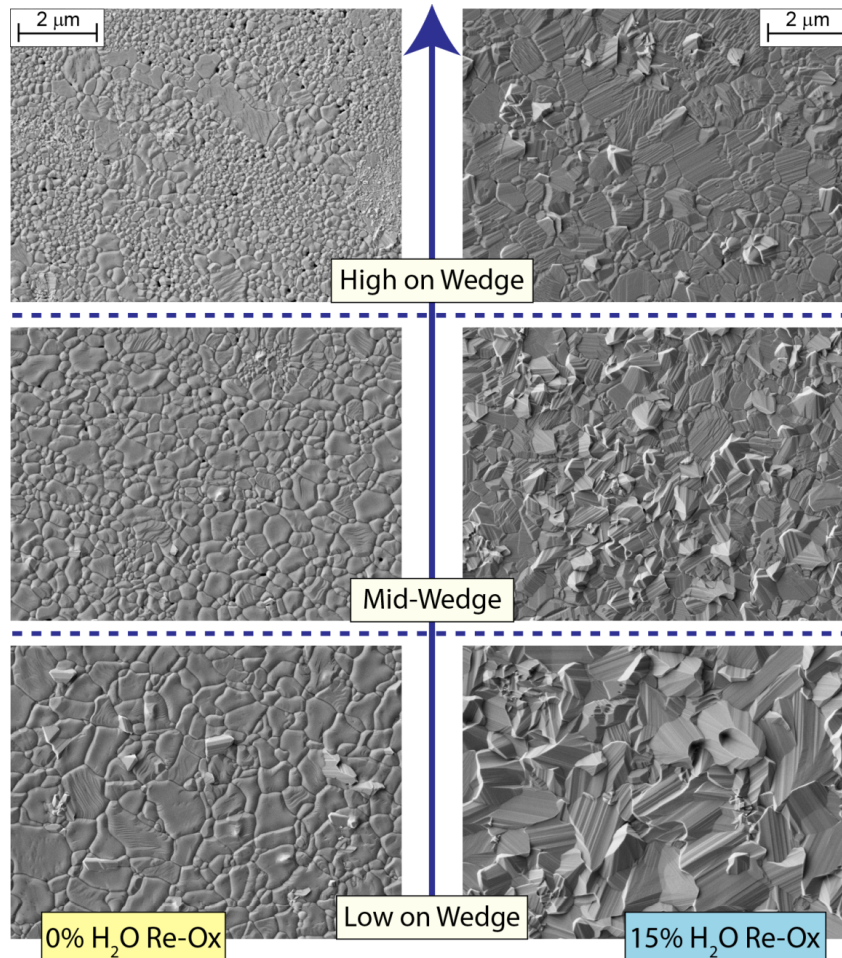

Standalone BC

- * Same results using a substrate-mounted vs. a standalone bond coat



TGO Development Studies: FIB and (S)TEM Studies

Use FeCrAlY to evaluate GBR chemistry in variable H₂O atm

- ▶ Expect to see heightened Fe in wet atm, as Fe²⁺ may substitute for Al³⁺ with proton incorporation.
- ▶ Prepare TEM cross-sections with FIB and Omniprobe

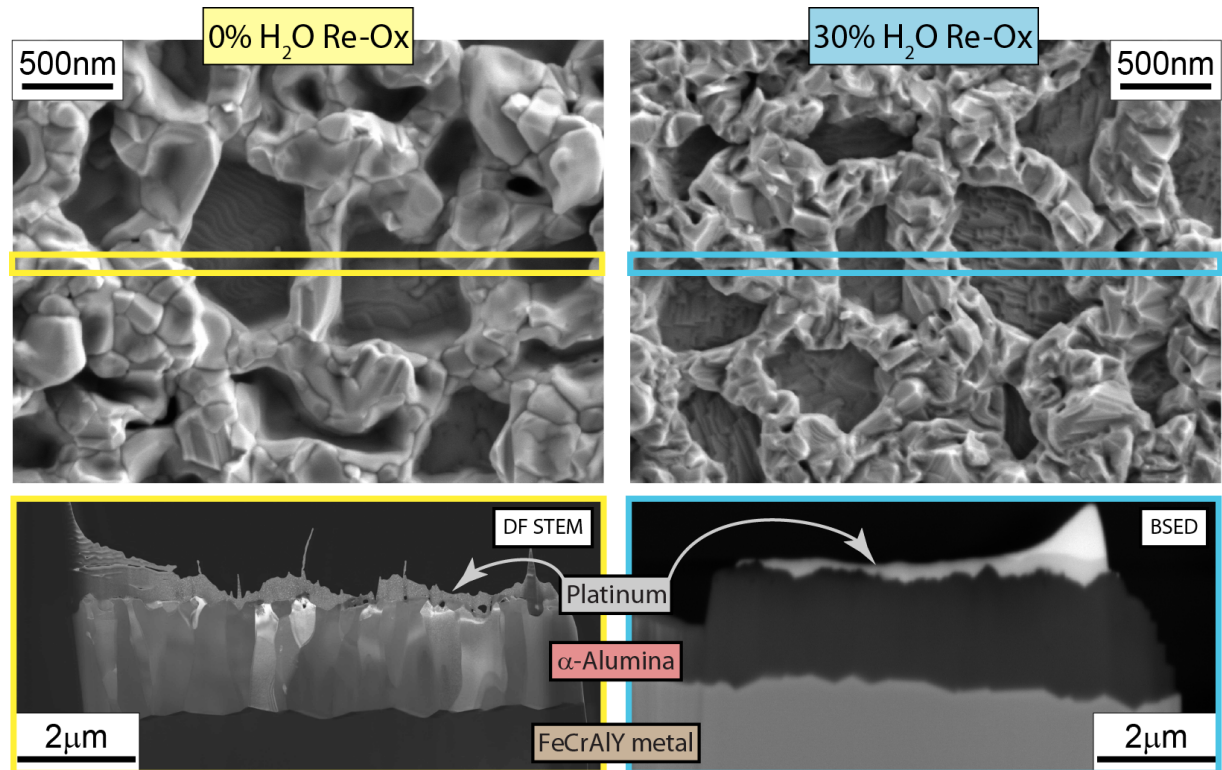

TGO Development Studies: FIB and (S)TEM Studies

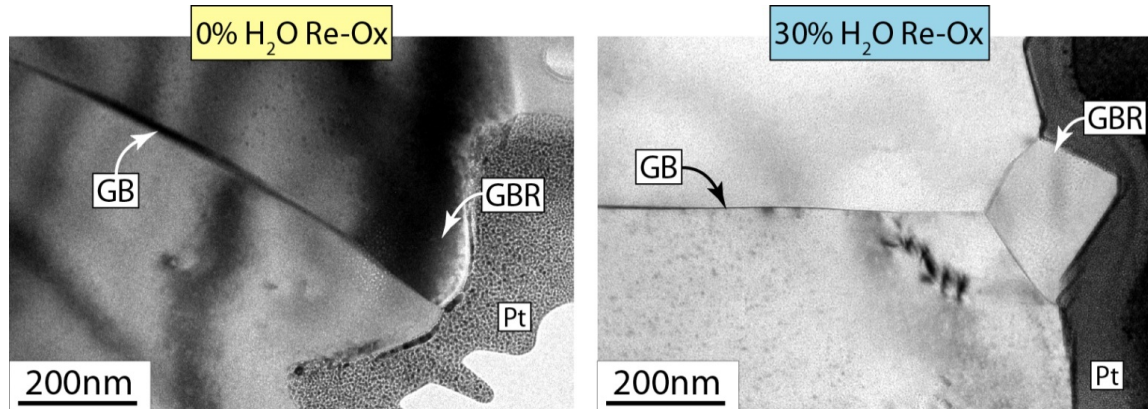

TEM

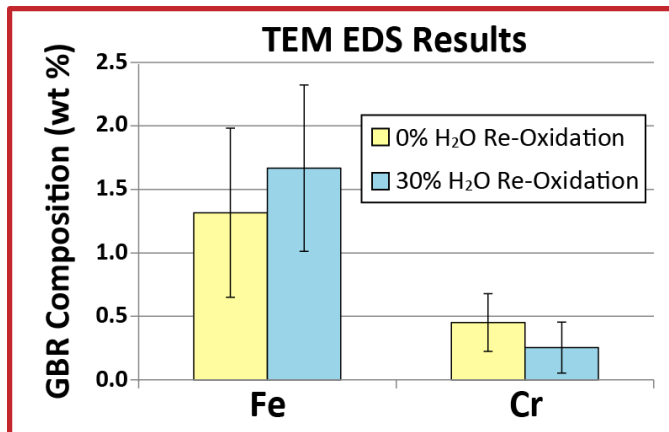

- ▲ Water vapor induces faceting of the grain boundary ridges.
- ◀ Fe and Cr composition of GBRs is statistically equivalent in dry and wet re-oxidation atm, indicating no change in cation diffusion.



TGO Development Studies: Tapered Specimen Studies

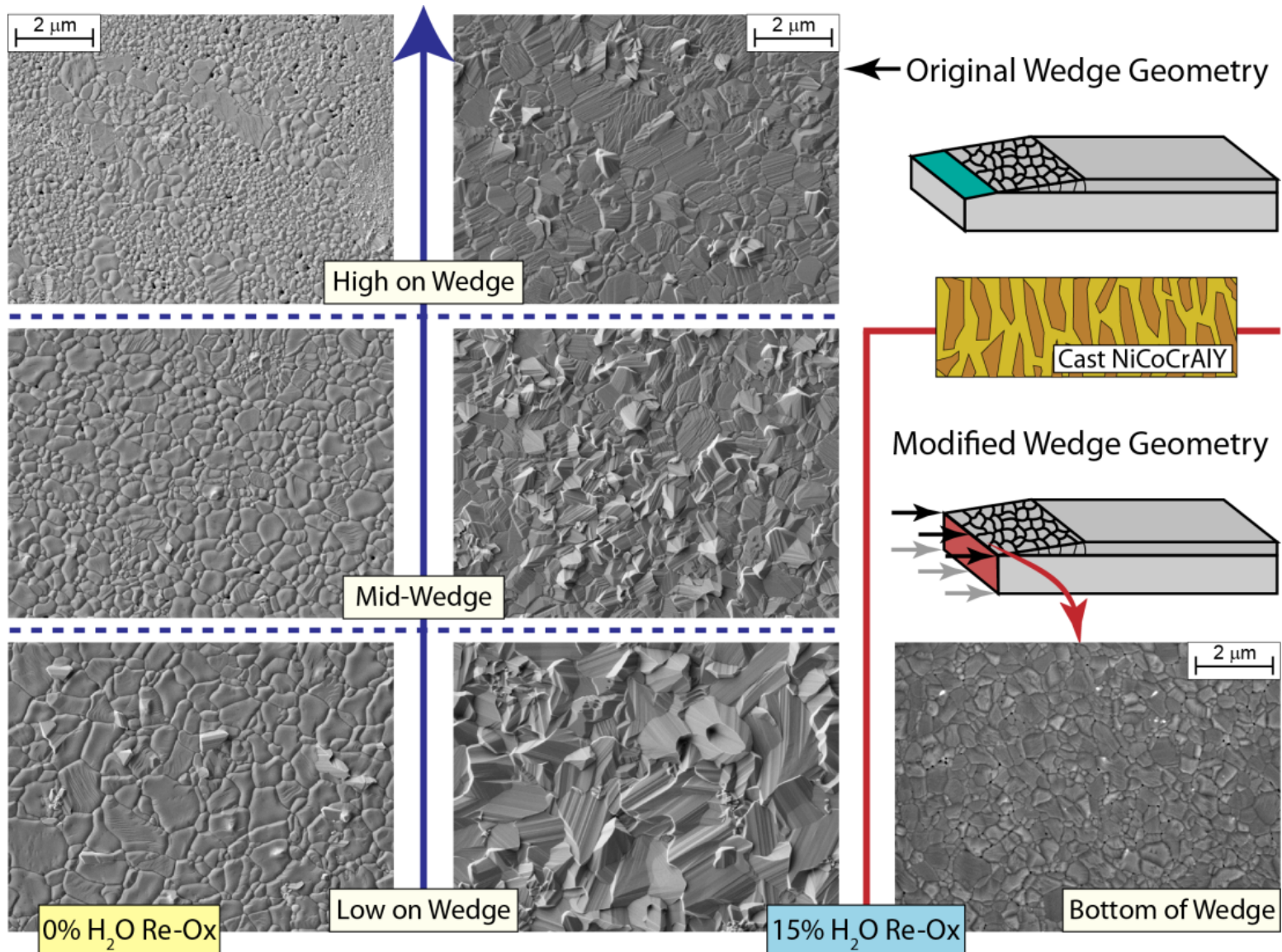

TGO Development Studies: Volatilization Effects

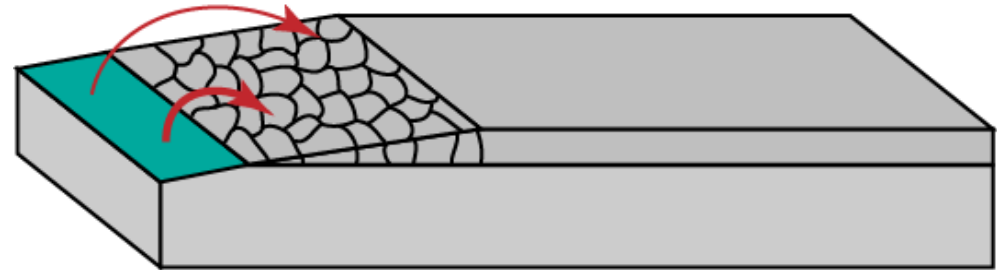
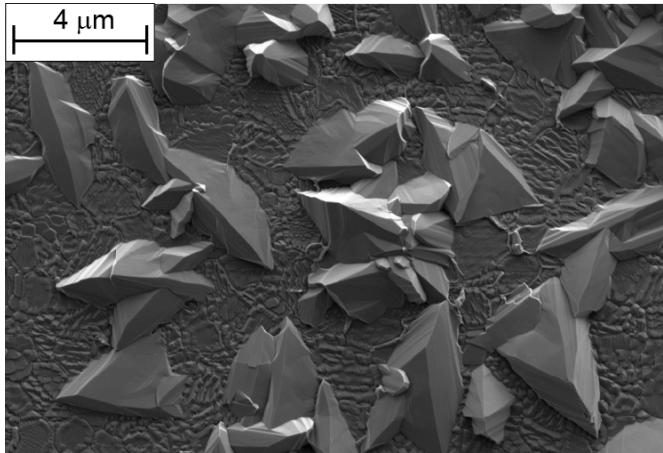

- The exposed, Al-depleted wedge (rich in Ni, Cr and Co) grows non-ideal oxides that volatilize and redeposit via vapor phase proportionately up the wedge

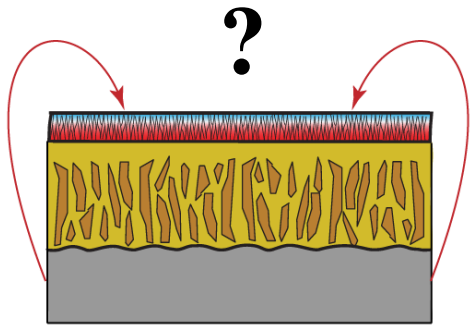

TGO Development Studies: XRD Measurements

XRD Results:



Same Furnace

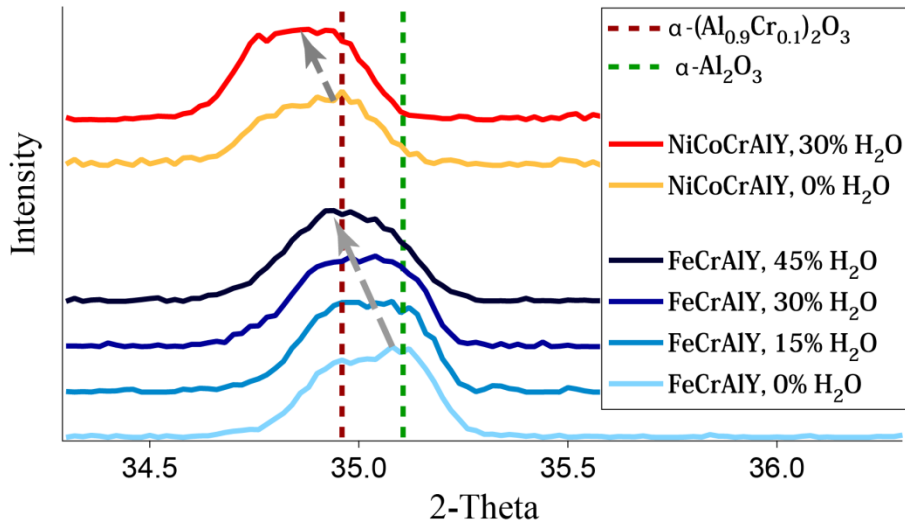

Separate Furnaces

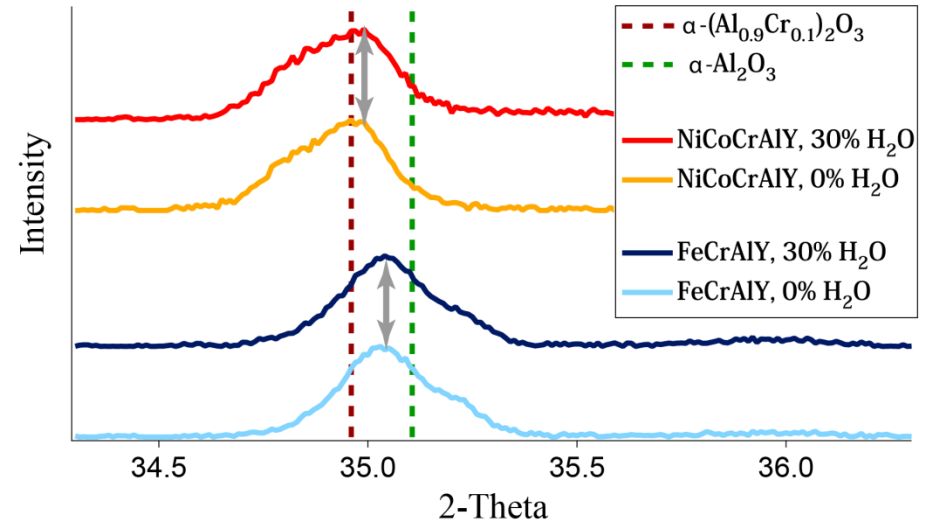

Volatilization

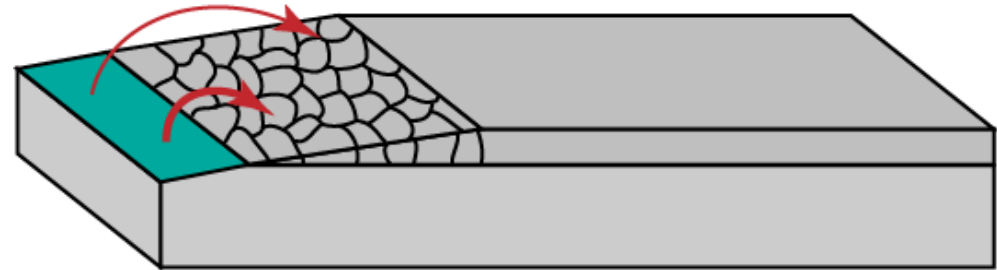
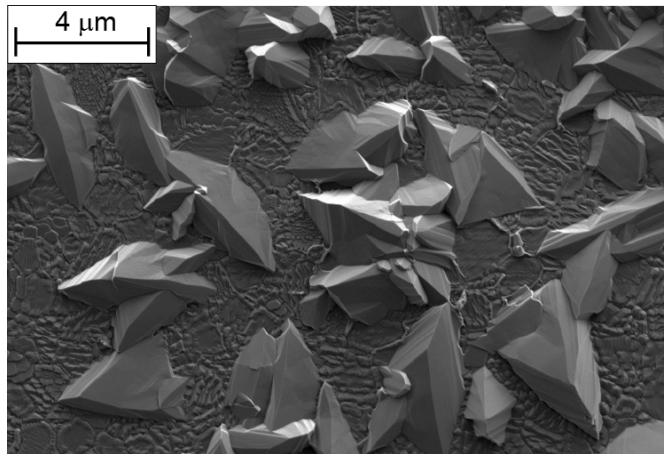

- The exposed, Al-depleted wedge (rich in Ni, Cr and Co) grows non-ideal oxides that volatilize and redeposit via vapor phase proportionately up the wedge

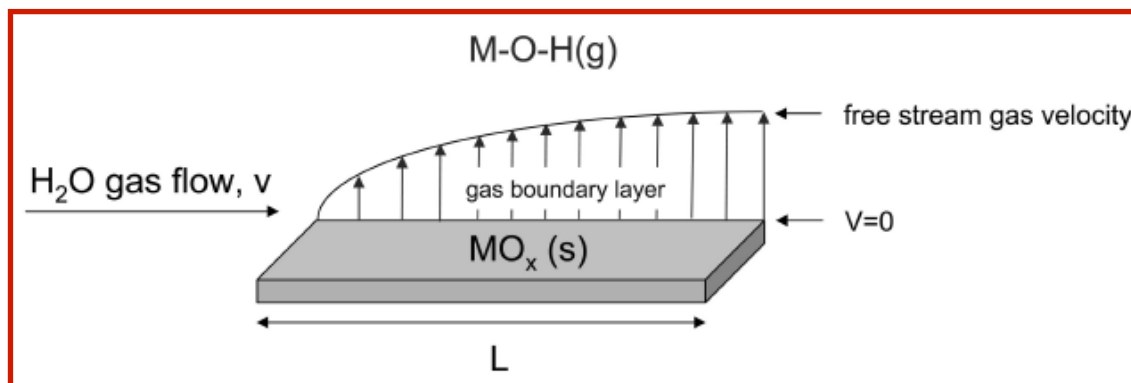
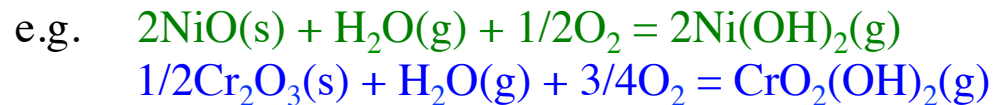
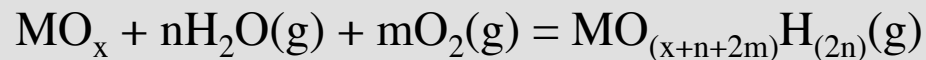

- Solid spinels can be synthesized via vapor phase combination of M^{2+} and M^{3+} metal hydroxides (e.g. Ni^{2+} and Cr^{3+})

Opilia EJ, JOM (2006)



TGO Development Studies – Transient Stages

NiCoCrAlY & CoNiCrAlY:

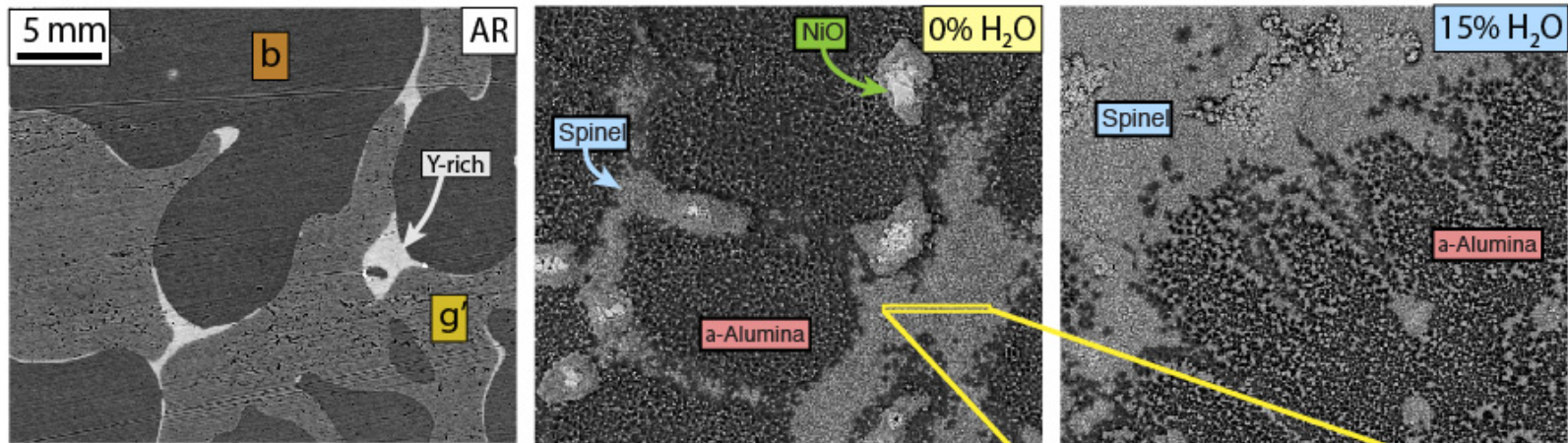

- ▲ Backscatter electron images show coarse b/g'/Y-rich phase distribution in as received (AR) NiCoCrAlY. When oxidized for "0 hours" at 1125°C (i.e. ramp up, ramp down at 5°C/min), coarse distribution of alumina (dark), spinel (medium), and NiO (light gray) results. More spinel is promoted at the TGO surface in 15% vs. 0% H₂O.

A thin lamella cross-section cut from the 0% H₂O sample reveals a bilayer TGO via dark field STEM imaging. Thickness of transient stage spinel is roughly equal in all H₂O environments; spinel surface coverage varies most.

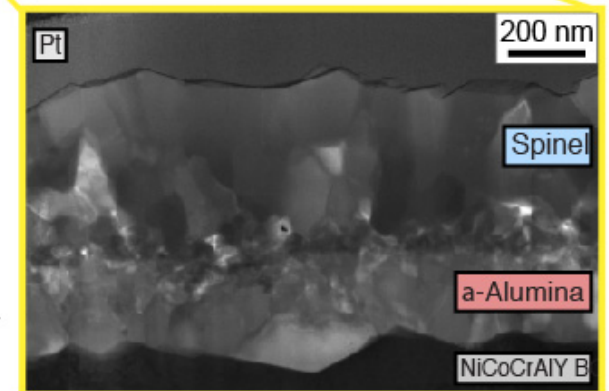

TGO Development Studies – Transient Stages

An activity diagram for a Ni-Al alloy system, shows three potential reaction pathways:

- ① Al-rich phase (e.g. b) forms α -alumina under steady state conditions
- ② Ni-rich phase (e.g. g') forms spinel during high P_{H_2O}/P_{O_2} transient stage
- ③ Ni-rich phase + high effective P_{O_2} grows transient NiO, which evolves into spinel via reaction with α -alumina / diffusing Al

(Schematic adapted from MJ Stiger et al, 1999)

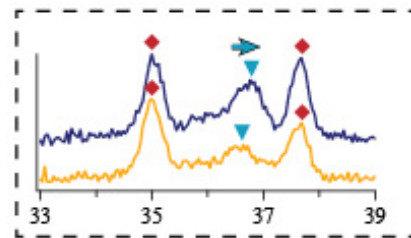
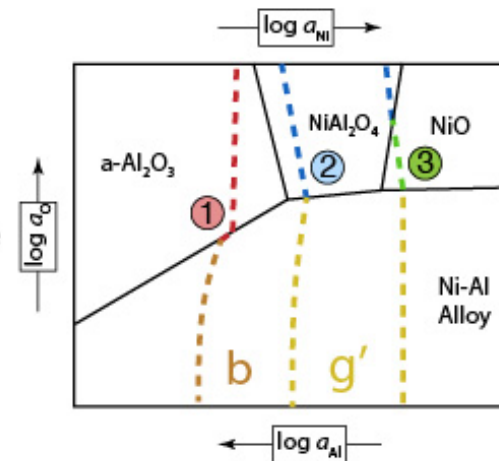

1 degree glancing angle x-ray diffraction of NiCoCrAlY confirms the presence of α -alumina and spinel in the transient, bilayer TGO. A close inspection reveals an increase in magnitude and a rightward shift of spinel peaks in water vapor, towards Ni and Al doping of the A and B sites, respectively.

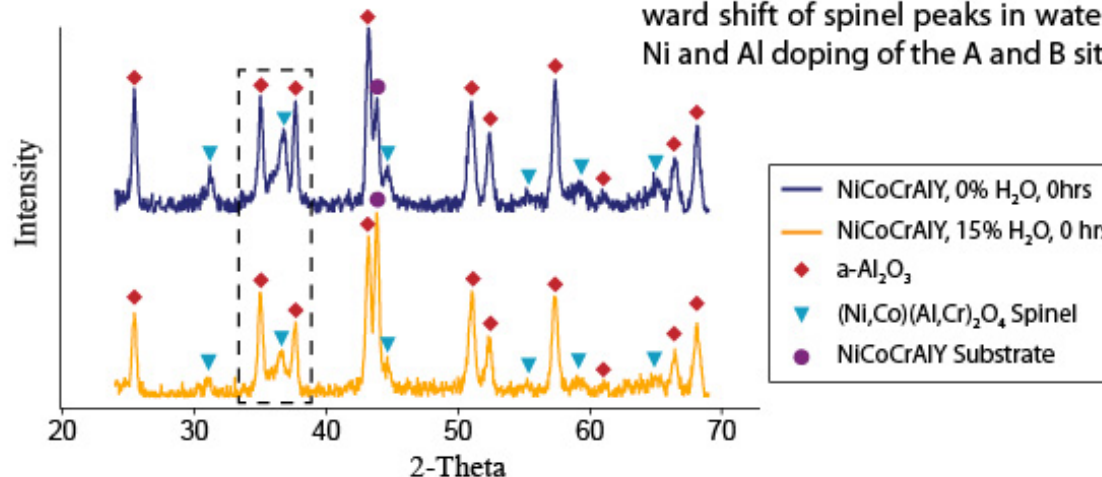

TGO Development Studies: Evidence of Ni Volatilization

Visual inspection of low magnification, plan view, backscatter electron images shows the relative distribution of alumina and spinel on the surface of the TGO

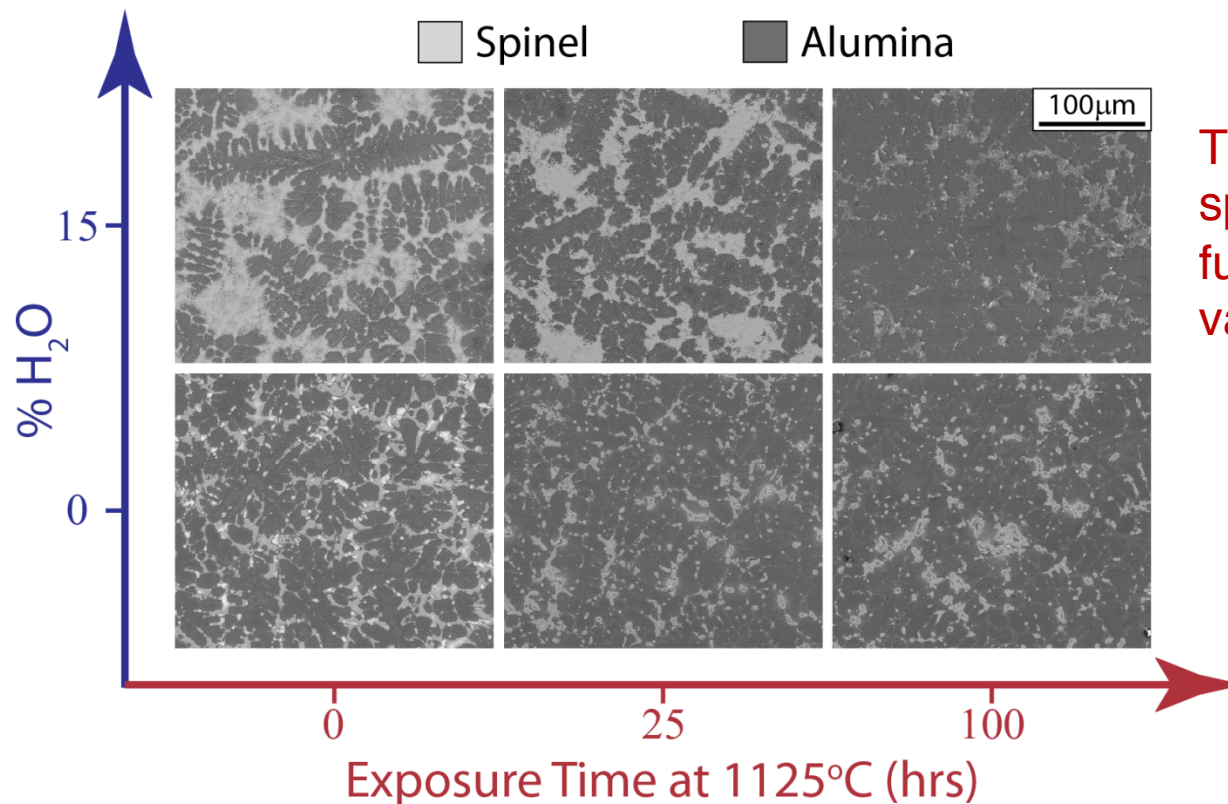

The amount of surface spinel *decreases* as a function of time in water vapor



TGO Development Studies: Evidence of Ni Volatilization

By thresholding plan view images, the amount of surface spinel (measured as a % of surface area coverage) can be quantified and plotted for many samples:

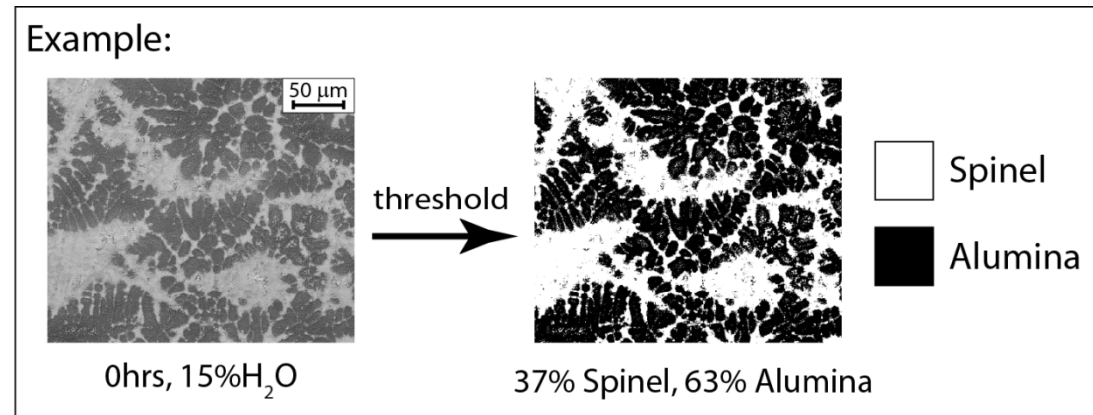

For all environments, spinel coverage decreases as a function of time. In water vapor, more spinel exists early in oxidation, but also disappears more rapidly.

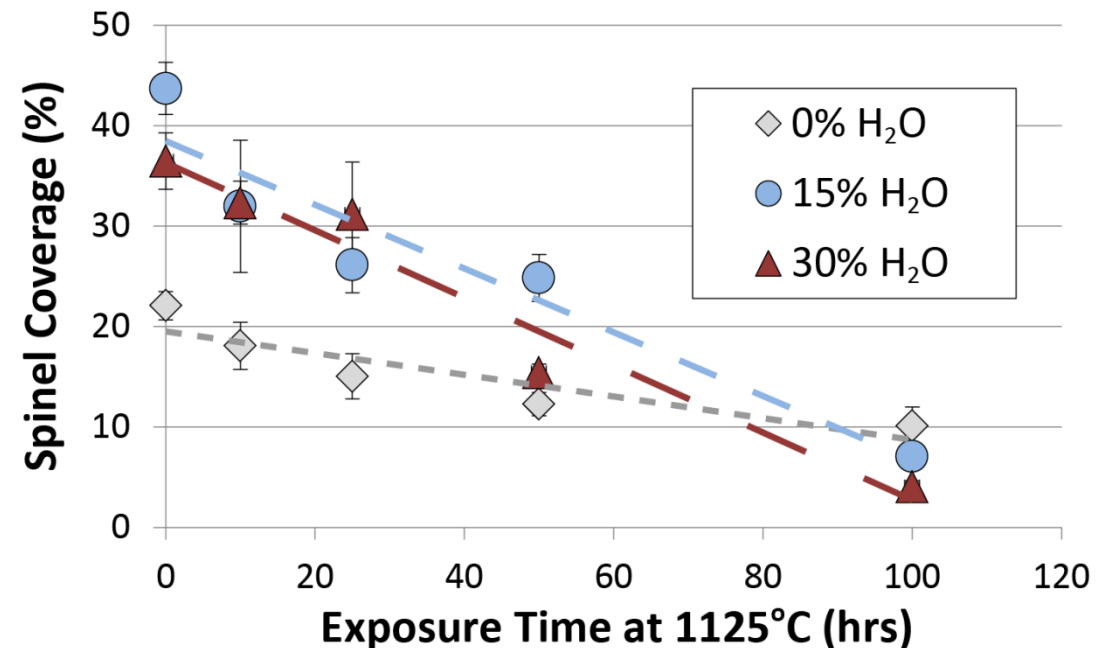

TGO Development Studies: Transient Oxidation & Volatilization

Focusing on the early stage of oxidation (0 hours at 1125°C), where spinel coverage is always highest with no top coat, spinel coverage can be plotted as a function of a) H₂O and b) O₂.

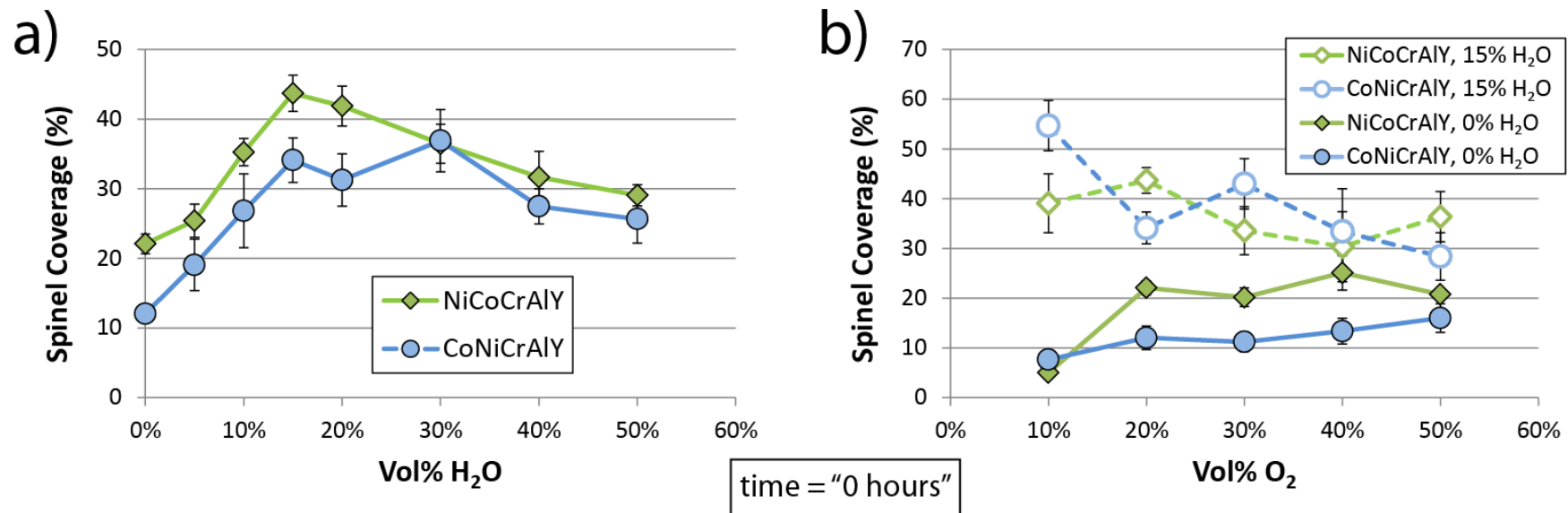

- For both NiCo- and CoNiCrAlY, spinel coverage increases as a function of water vapor to a point, before decreasing. It is likely that the decrease is due to volatilization: the rate of volatilization outstrips the rate of spinel growth at high enough H₂O. Experiments must be repeated with a top coat present to verify this.
- Spinel coverage also increases as a function of O₂; adding water vapor to any O₂ composition increases spinel coverage as well.



Evidence of Ni Volatilization

$\text{Ni}_{70}\text{Al}_{30}$ 100hrs, Plan View

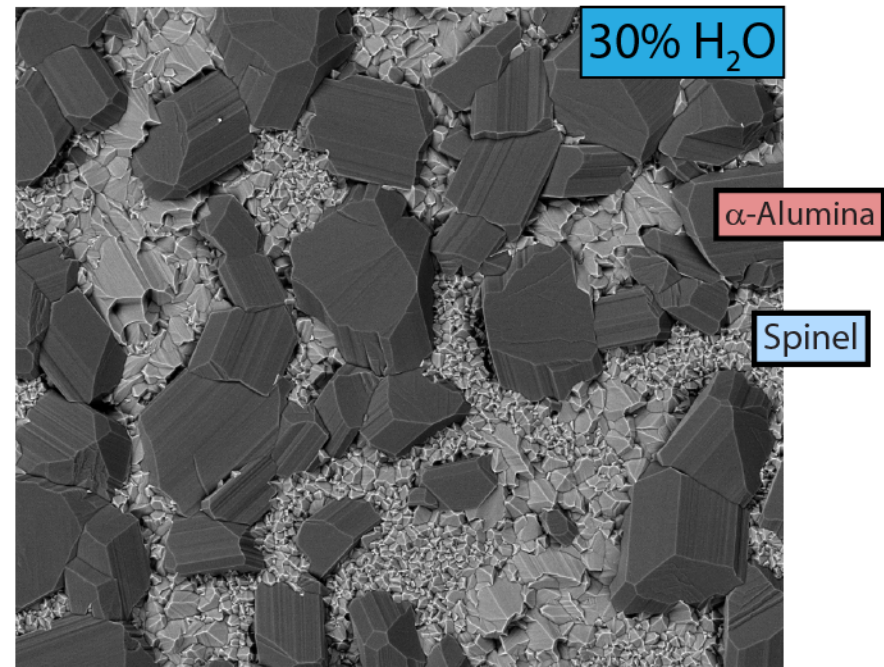
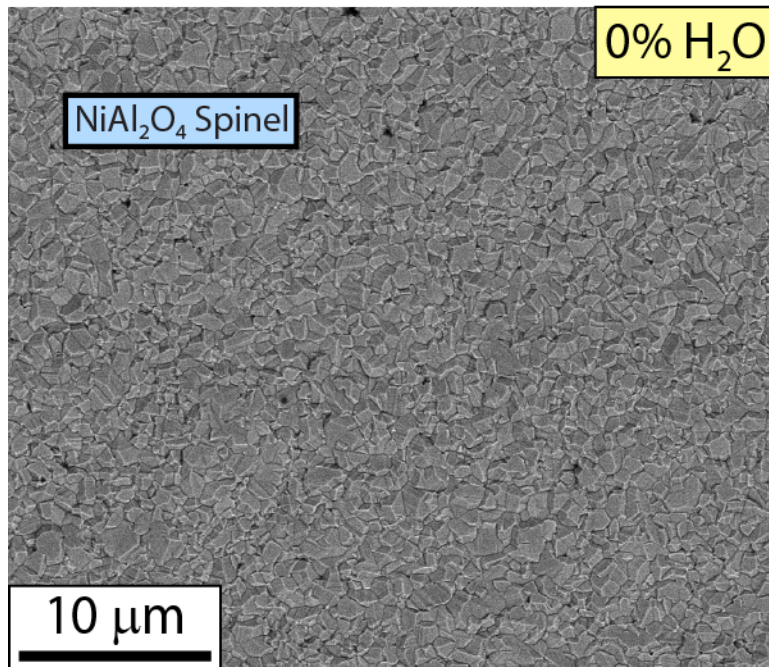

In a simple Ni-Al alloy, a bilayer oxide forms in 0% H₂O, with NiAl₂O₄ spinel covering the entire surface (alumina is beneath, not pictured). At 30% H₂O, large alumina grains protrude from the surface, possibly the result of Ni volatilizing away, causing NiAl₂O₄ to reduce to Al₂O₃. This could be similar to what is observed in NiCoCrAlY, only more severe because the amount of spinel is so much greater for an alloy not designed to prevent its formation. The heavily faceted alumina grains are characteristic of a water vapor interaction.



Evidence of Ni-species Redeposition

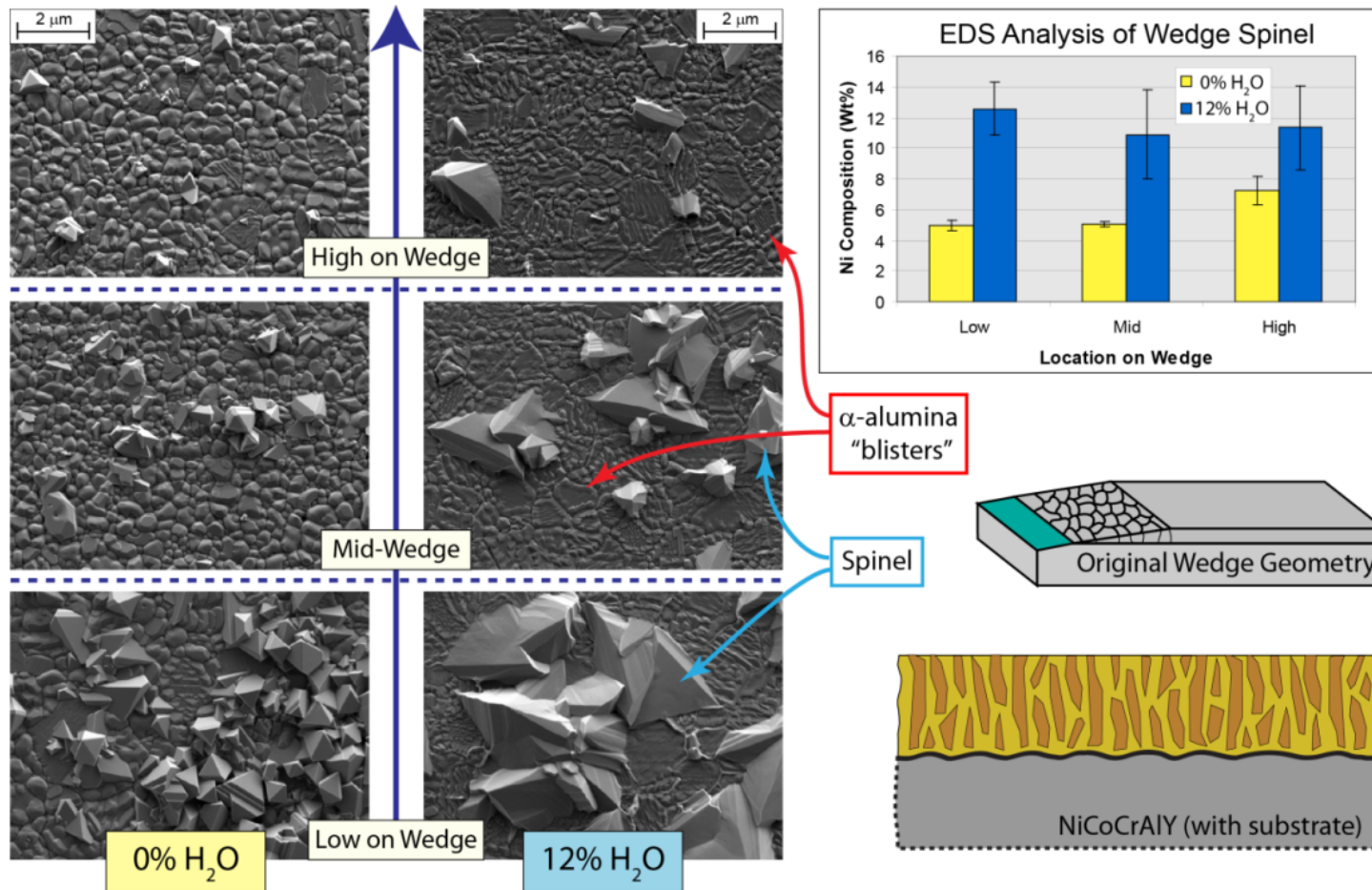

Running a wedge re-oxidation experiment on NiCoCrAlY with the “original wedge geometry” (i.e. exposed, Al-depleted bond coat surface at base of wedge), large spinel domains form on the wedge surface after just 4 hours. Ni is detected in the spinel by EDS.



TBC Degradation Studies: Destabilization w/ high pH₂O

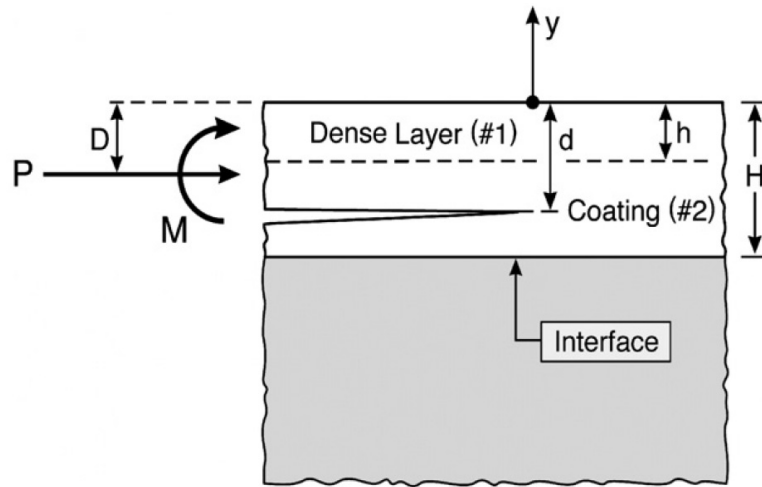

Sintering Effects

Y-stabilized ZrO₂

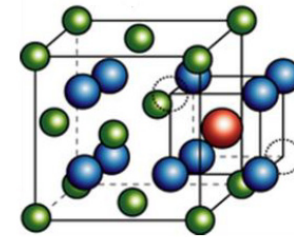
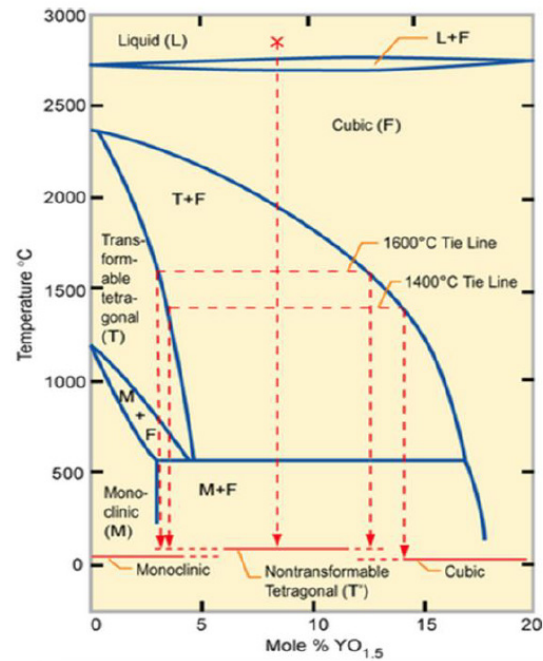

Fluorite

Phase Instability



TBC Degradation Studies: Materials Preparation

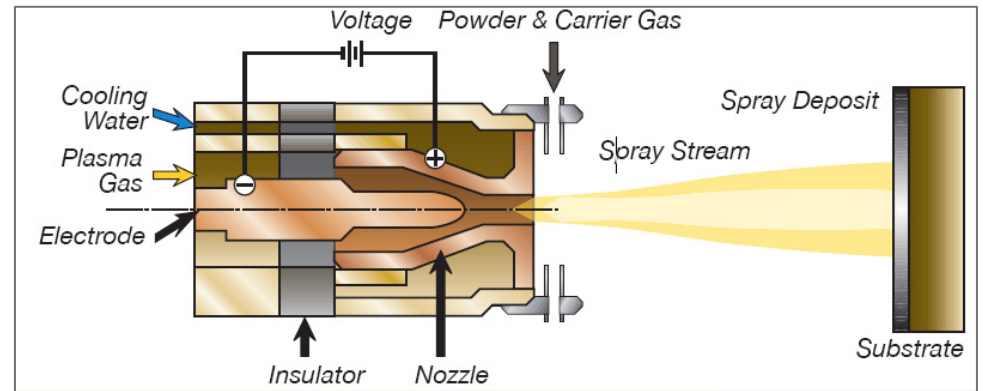

TBC Degradation Studies: Raman and XRD Measurements

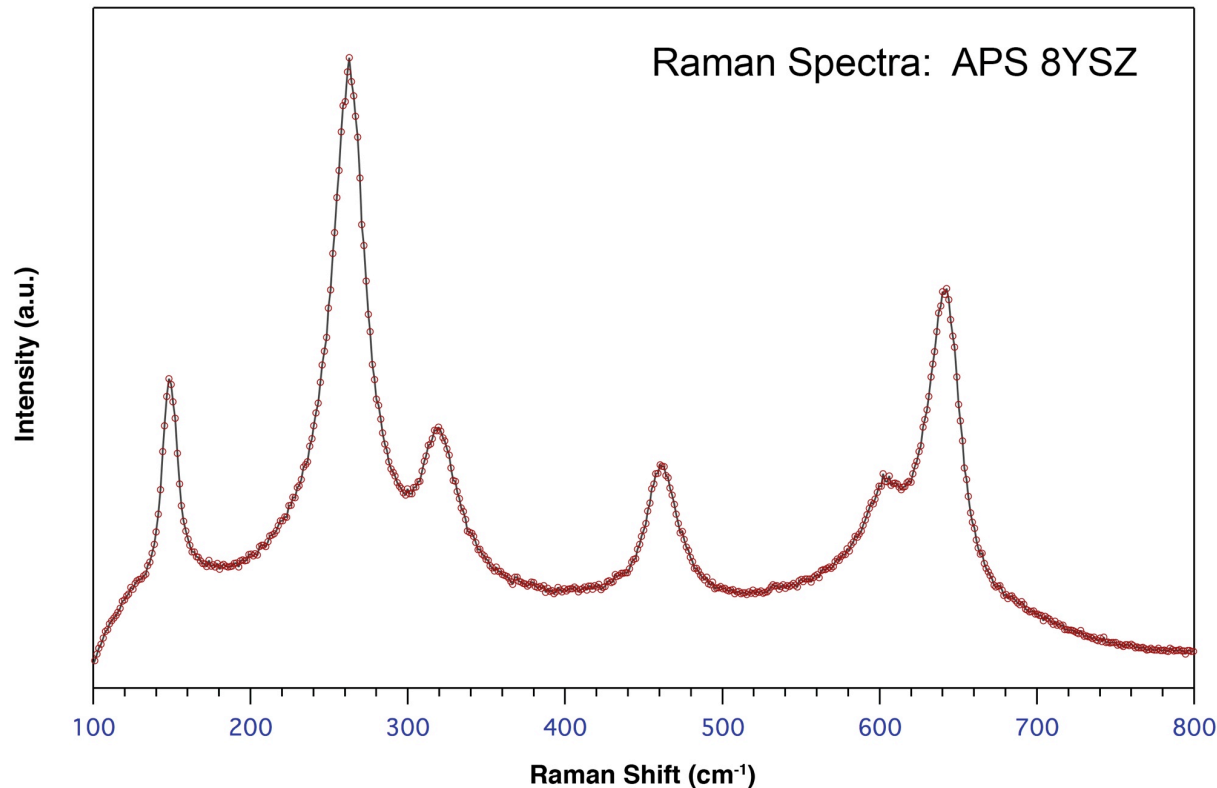

Raman spectroscopy is being used to monitor phase evolution as a function of environmental parameters under extended aging exposures

In-situ XRD Measurements are also being utilized for such measurements



TBC Degradation Studies: Fly Ash and CMAS Studies

Coal gasification may leave residual fuel impurities to combine with non-combustibles in the intake air to form surface deposits and infiltrating phases.

Understanding the deposit thermo-chemical and thermo-physical properties, and the resulting thermo-mechanical affects is critical to ensuring hot-section materials durability.

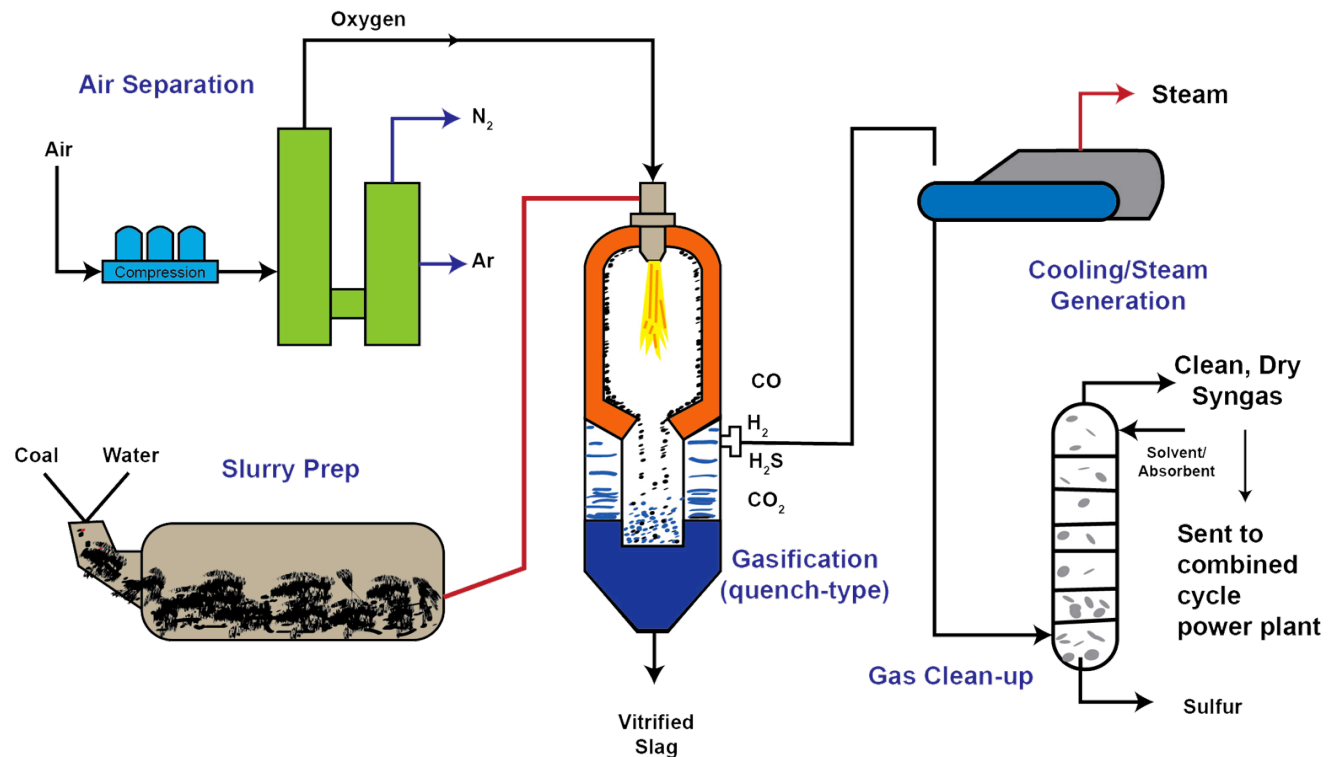

CMAS ($\text{CaO-MgO}_2\text{-Al}_2\text{O}_3\text{-SiO}_2$) – Analogous Failure Processes?

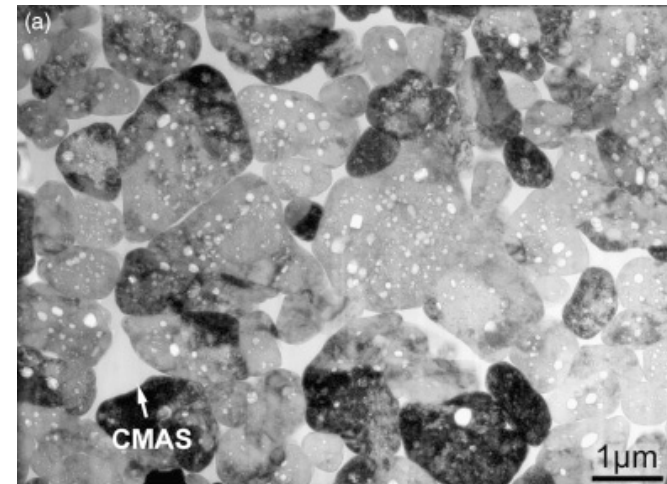

Carlos Levi, A.G. Evans (UCSB)

Nitin Padture (Ohio State)

Comprehensive Understanding of
Mechanistic Basis of Coating Degradation

Dissolution of YSZ

Melt Infiltration

Mitigation Strategies

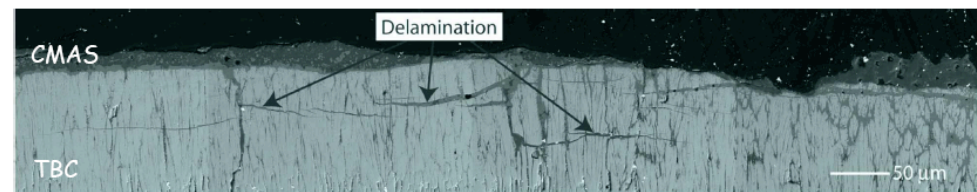
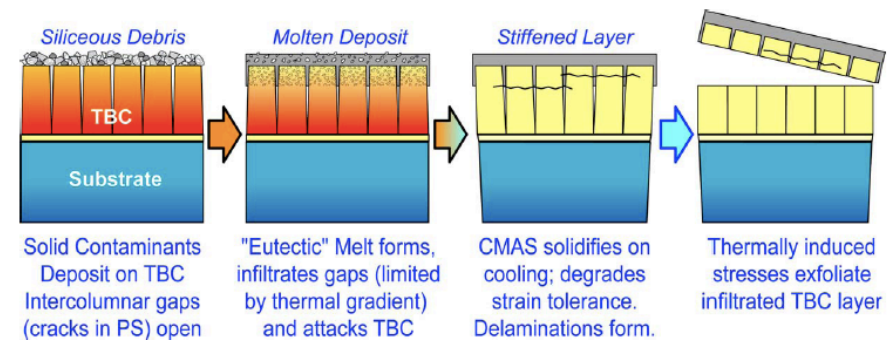

Mercer, Faulhaber, Evans, Darolia, 2005



Advanced Materials & Structures Laboratory
– Power Systems and Propulsion Materials Group –

UTSR – Annual Workshop 121004

43

Eyjafjallajokull Volcano Eruption - Iceland



Effects of volcanic ash on jet engine

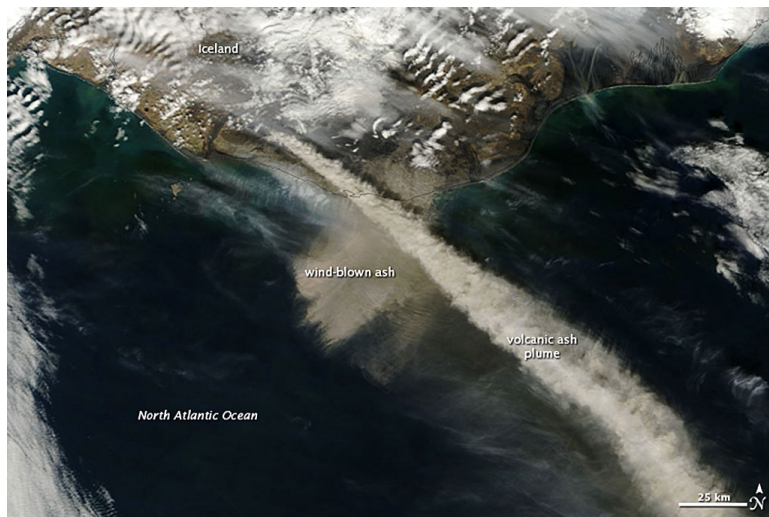
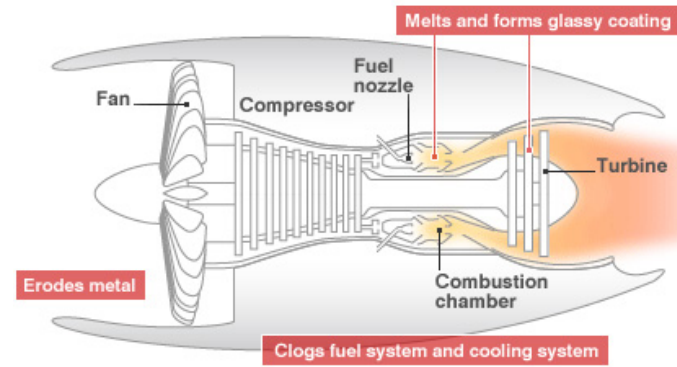

TBC Degradation Studies: Fly Ash and CMAS Studies

Wt%	Spectrum 1	Spectrum 2	Spectrum 3	Average
Al	9.07	9.40	8.97	9.15
Ca	4.93	5.20	5.01	5.05
Fe	7.39	8.90	7.45	7.91
K	1.52	1.77	1.52	1.60
Mg	0.80	0.76	0.79	0.78
Na	2.56	2.24	2.15	2.30
O	49.03	45.68	47.35	47.35
Si	25.91	26.49	25.56	25.99
Ti	0.35	0.46	0.36	0.39

Compound	Wt%
Al ₂ O ₃	17.28
CaO	7.23
Fe ₂ O ₃	11.31
K ₂ O	1.93
MgO	1.30
Na ₂ O	3.10
SiO ₂	56.31
TiO ₂	0.65

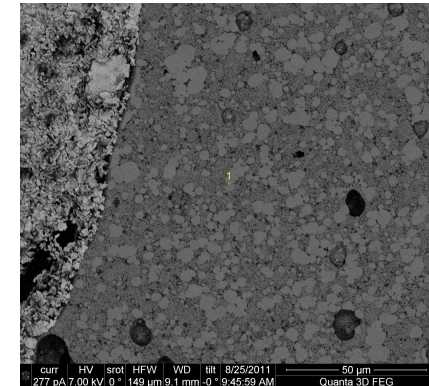

Energy Dispersive Spectroscopy of Petcoke/Coal blend bottom ash. Contains a high weight percent of silica and iron differentiation it from CMAS.

Compound	Wt%
Al ₂ O ₃	19.79
C	5.40
CaO	4.40
Fe ₂ O ₃	4.26
K ₂ O	3.53
MgO	0.78
Na ₂ O	0.59
P ₂ O ₅	0.44
S	1.21
SiO ₂	58.65
TiO ₂	0.56

Data obtained from a study of fly ash obtained from the IGCC plant in Puertollano Spain.

Oriol Font et.al



TBC Degradation Studies: Fly Ash and CMAS Studies

Component (wt %)	Fly Ash Type			
	Typical Coal	Synthetic Coal	Biomass (Pulverized Wood)	Lab Fly Ash
SiO ₂	40.0	55.0	14.1	58.0
Fe ₂ O ₃	17.0	10.0	2.7	4.0
Al ₂ O ₃	24.0	25.0	2.9	19.0
CaO	5.8	5.0	20.7	4.0
Na ₂ O	0.8	1.0	1.0	0.0
K ₂ O	2.4	1.0	8.1	3.5 (K ₂ SO ₄)
MgO	> 0.2	> 0.2	4.0	0.0

A representative CMAS composition (believed to be relevant for HHC/syngas fueled systems) is being synthesized, characterized, and utilized in TBC degradation studies.

Ca	Mg	Al	Si	Fe
12	5	4	6	20

Free-standing APS TBC materials are being subjected to CMAS deposit melting and infiltration exposures under isothermal conditions. Also preparing Nitrate-based solutions for burner-rig based exposures (under thermal gradient conditions).



CMAS Degradation of YSZ: Microstructure Dependence

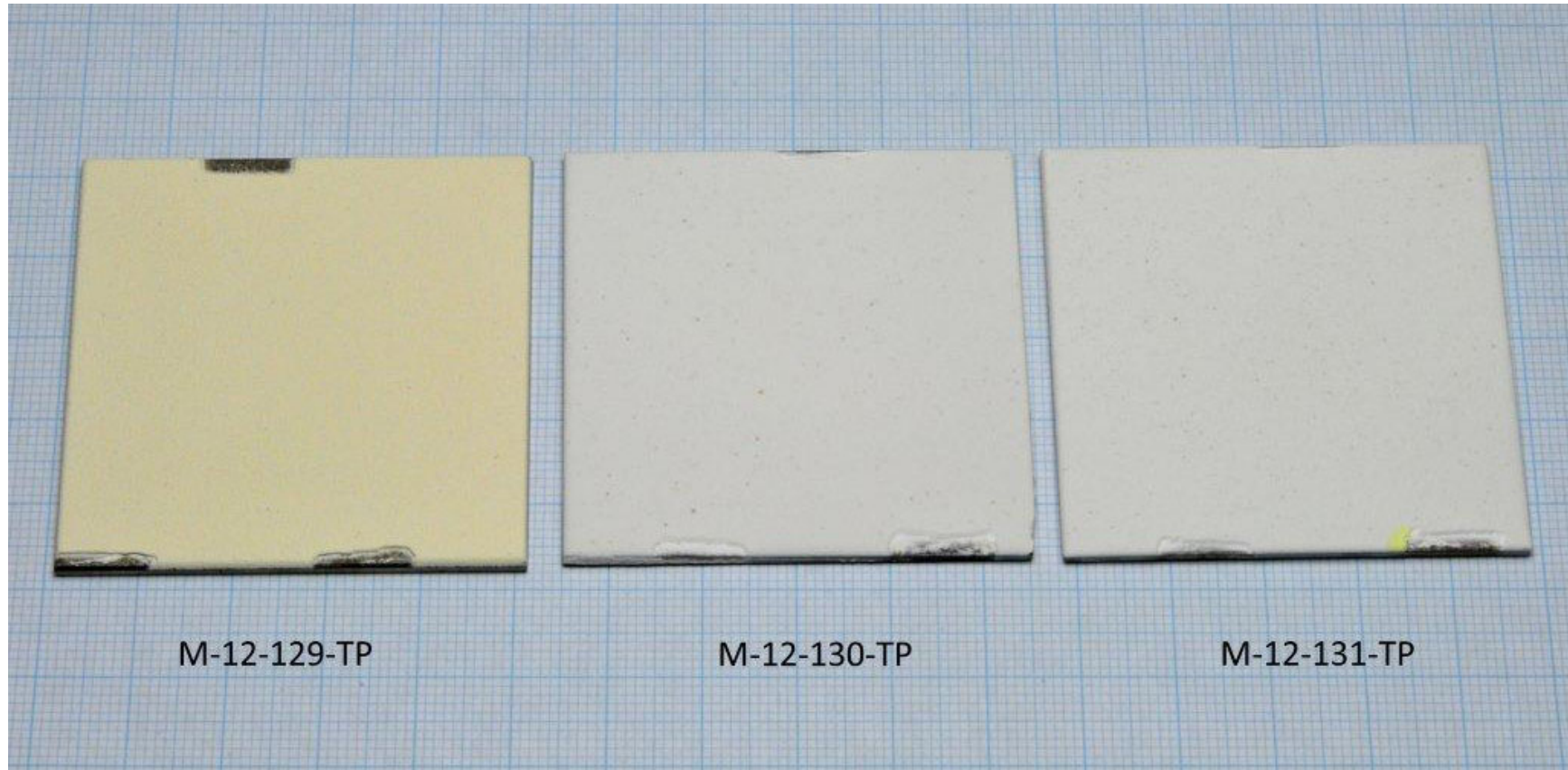

- Materials were sprayed at three distinct conditions to systematically control microstructural characteristics, and were then removed from substrate to carry out experiments on free-standing layers.



CMAS Degradation of YSZ: Microstructure Dependence

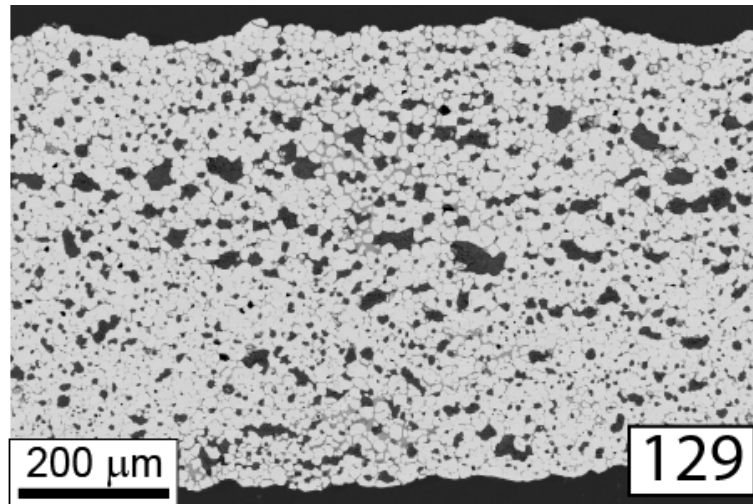

*View of full sample thicknesses
(image widths = 1mm)*

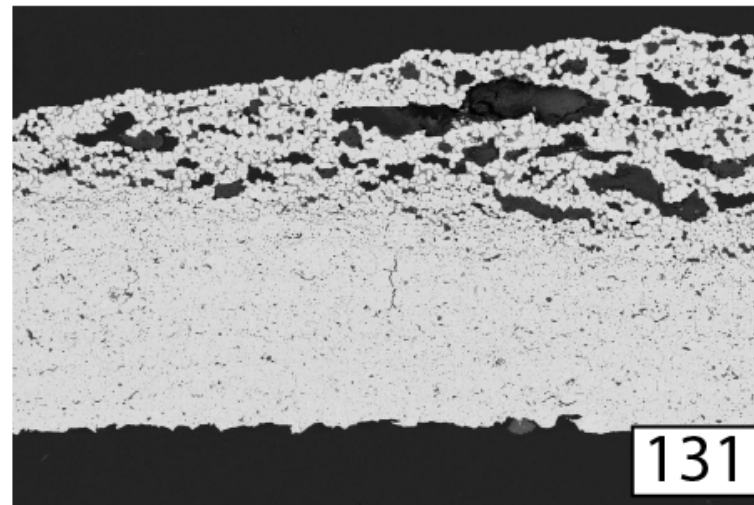
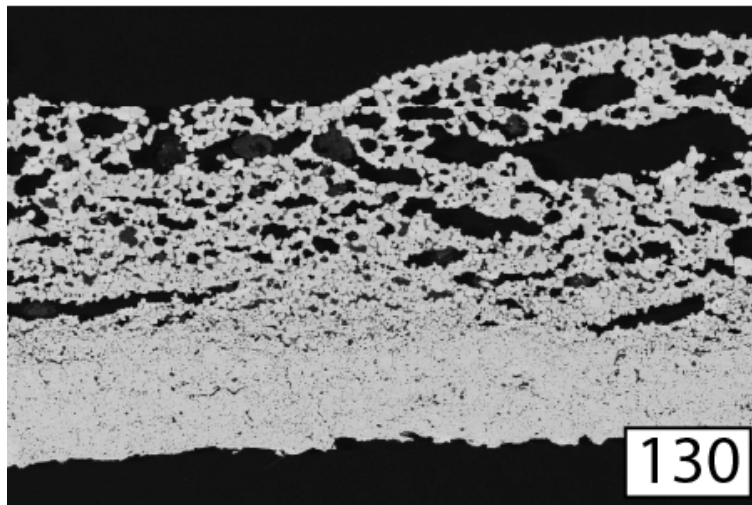

- These images represent the worst areas of CMAF attack on three samples



CMAS – Based Degradation of YSZ: Thermo-Chemical Interactions

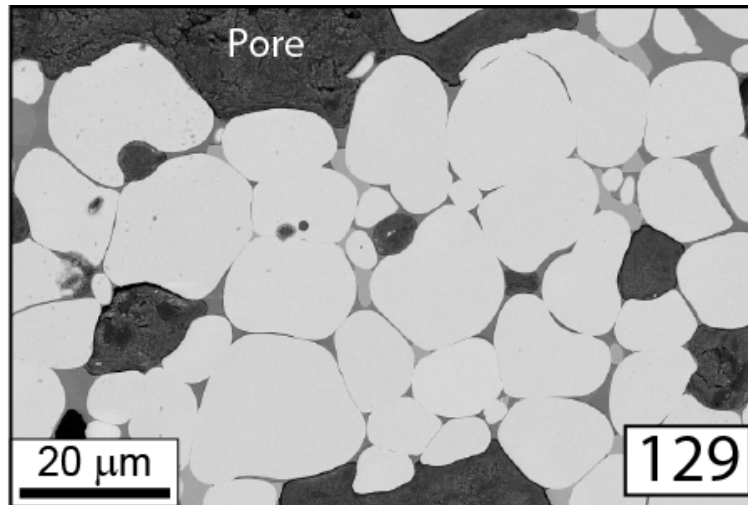

*View from middle of cross-section
(image widths = 100mm)*

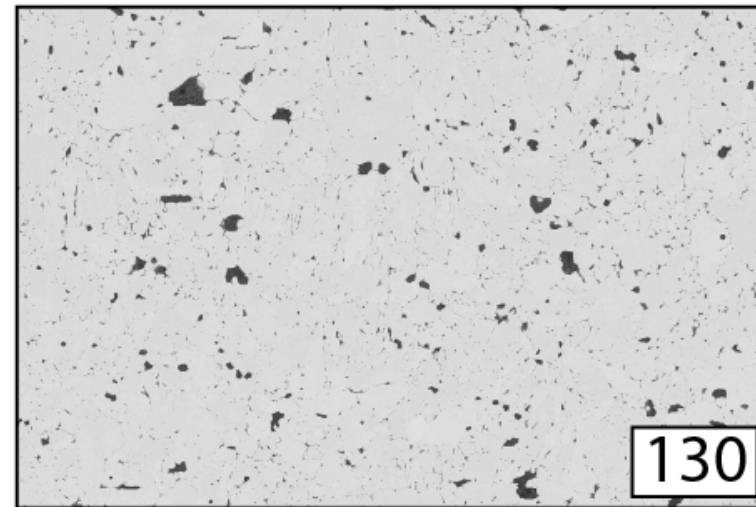
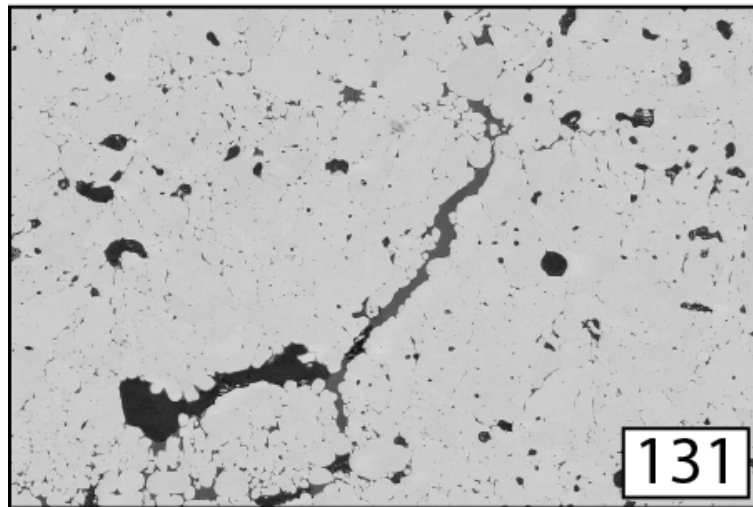

- Evidence of reprecipitation of YSZ phase after CMAF attack in all three samples, with glassy phases interspersed between (also in vertical cracks)



CMAS – Based Degradation of YSZ: Thermo-Chemical Interactions

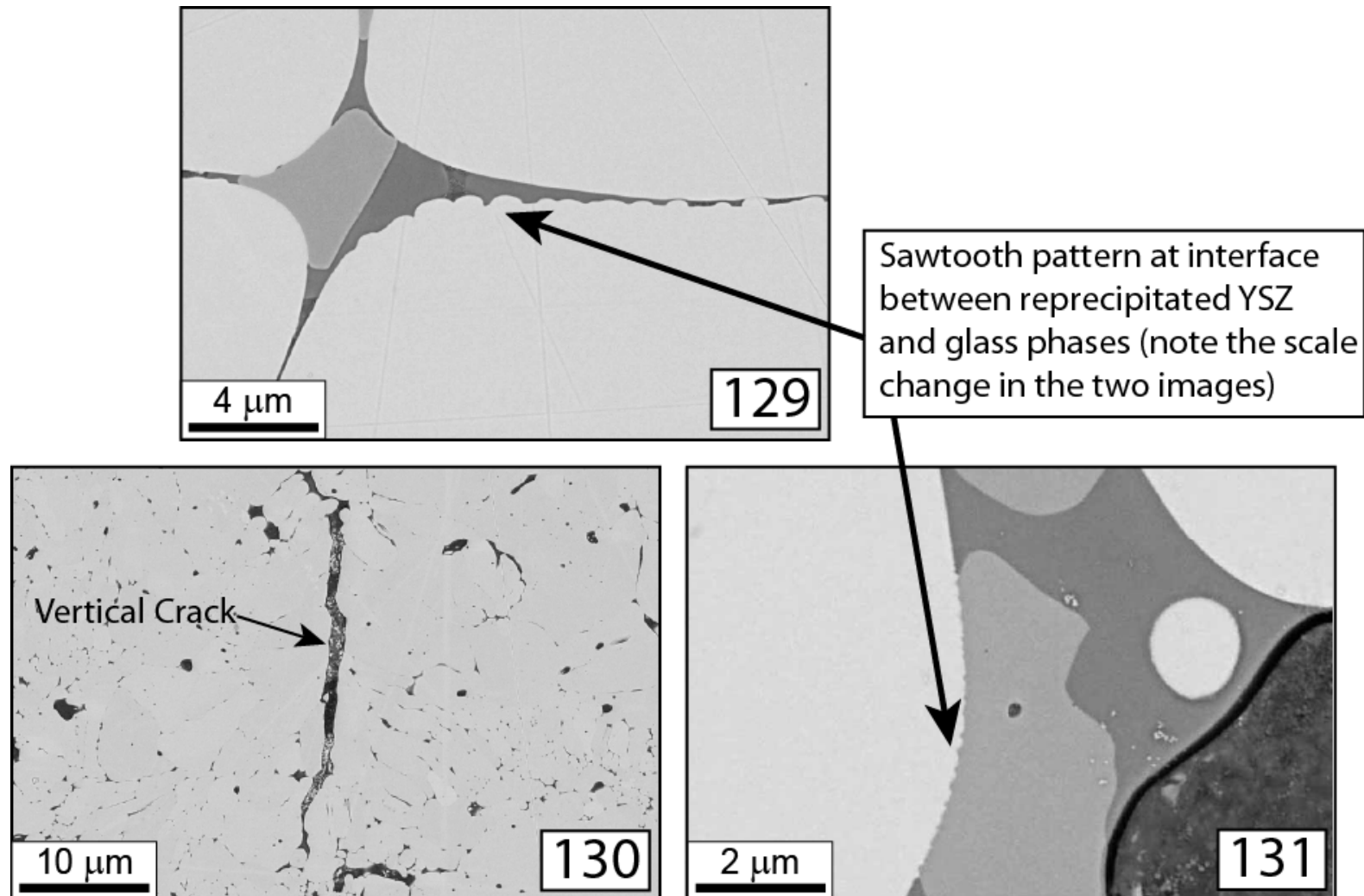

- Some interesting features seen at higher magnification



CMAS – Based Degradation of YSZ: Thermo-Chemical Interactions

	M-12-129-TP-CMAF EDS		
	Weight %		
	Coating	Light CMAF	Dark CMAF
Y	3.2	0.3	1.5
Zr	64.9	3.7	9.0
O	27.6	34.4	41.6
Ca	1.1	0.6	13.1
Mg	0.2	0.6	2.2
Al	0.0	1.7	5.3
Fe	3.0	57.9	13.9
Si	0.0	0.9	13.5

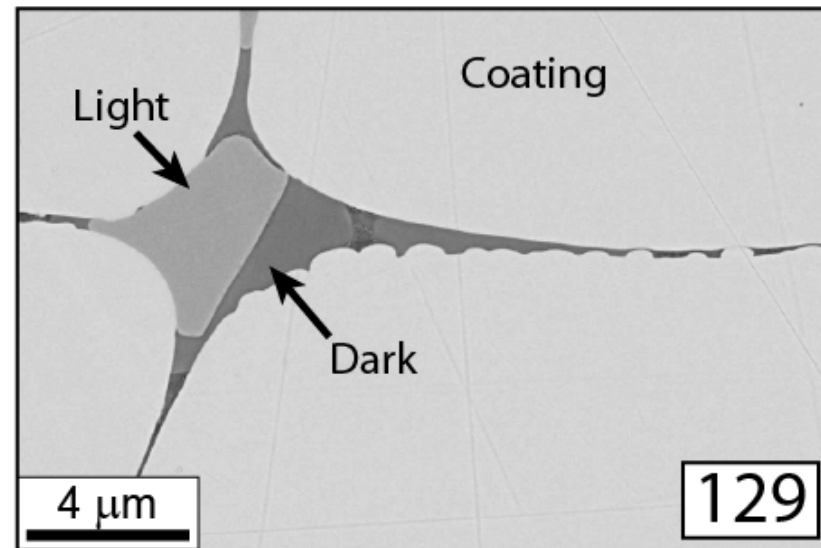

- Chemical composition of the reprecipitated APS YSZ coating and the light and dark glassy CMAF phases for sample -129 (APS)



New Materials – Rapid Assessment of Thermo-Chemical Interactions

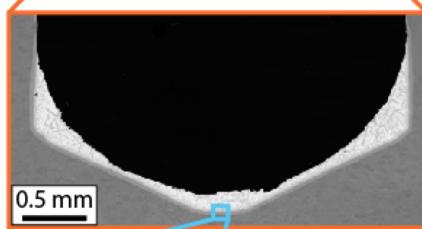
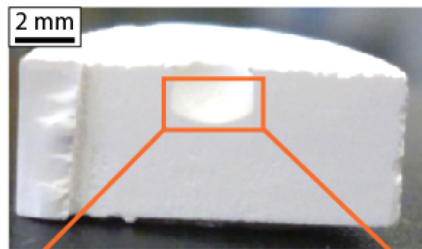

While this study was mainly focused on the CMAS resistance of TBC candidate ceramics, the same methodology can be applied to environmental barrier coating (EBC) materials as well. The results for one such material, Mullite ($3Al_2O_3 : 2SiO_2$), are shown here, apart from the TBC results, to serve as an example of the methodology used.

An infiltrated, cross-sectioned pellet appears at top left and, below it, an SEM micrograph of the entire drill bit hole with the CMAS reaction zone along the bottom surface. All SEM images presented here were captured with a backscatter electron detector to help observe atomic number contrast.

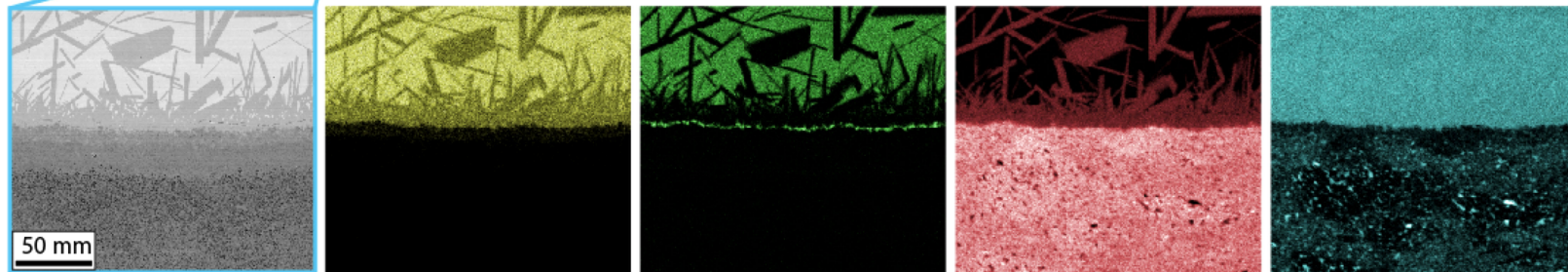

New Materials – Rapid Assessment of Thermo-Chemical Interactions

After sintering, any CMAS that has not infiltrated the substrate is observed as solidified glass at the surface of the drilled hole. Both the average CMAS penetration depth (blue arrows) and the average thickness of residual CMAS glass above the oxide (yellow arrows) can be calculated by taking measurements along the entire radial penetration front. Values for all four TBC candidate materials are listed in the table below. Not surprisingly, there is an inverse correlation between the two measurements. 5Yb-SrZrO₃ best resisted CMAS, 4YSZ the worst.

Ceramic Oxide	Avg. CMAS Penetration Depth (μm)	Avg. Thickness of Residual CMAS Glass Above Oxide (μm)
4YSZ	500	0
Gd ₂ Zr ₂ O ₇	90	75
GdYbZr ₂ O ₇	75	80
5Yb-SrZrO ₃	55	110

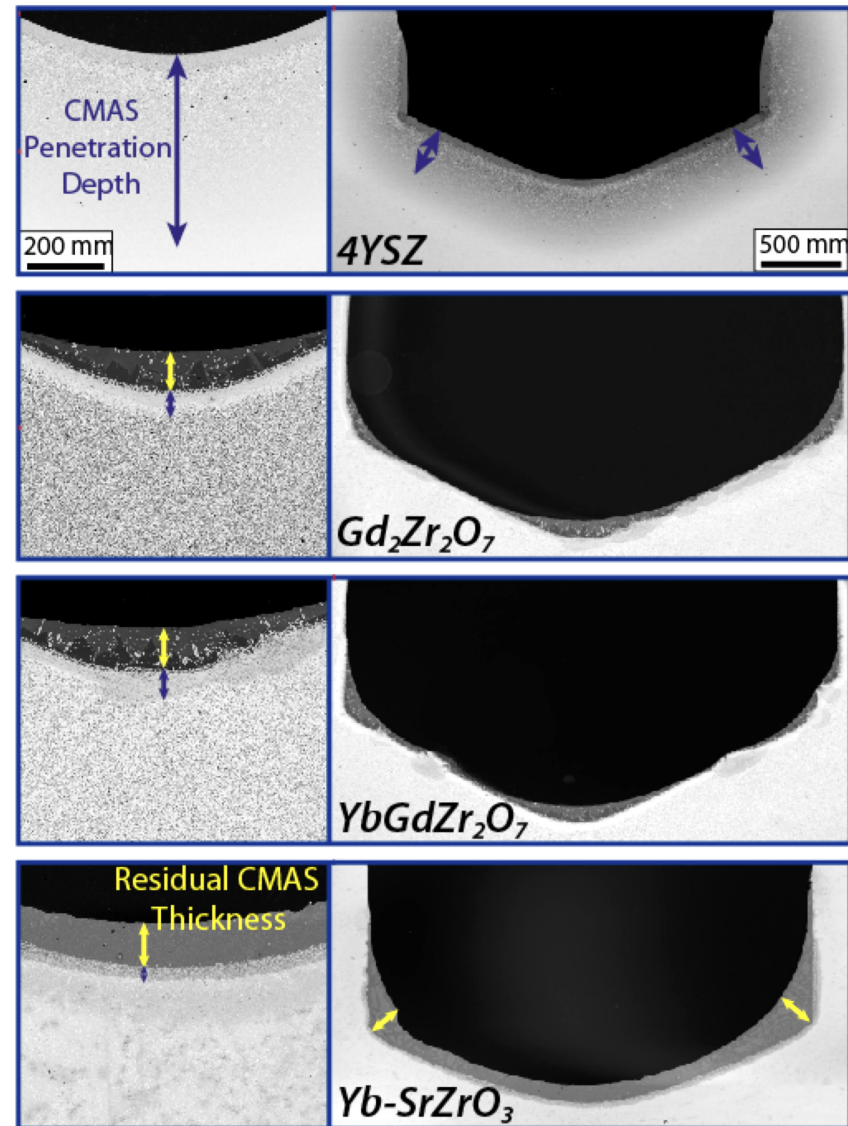

New Materials – Rapid Assessment of Thermo-Chemical Interactions

$Gd_2Zr_2O_7$

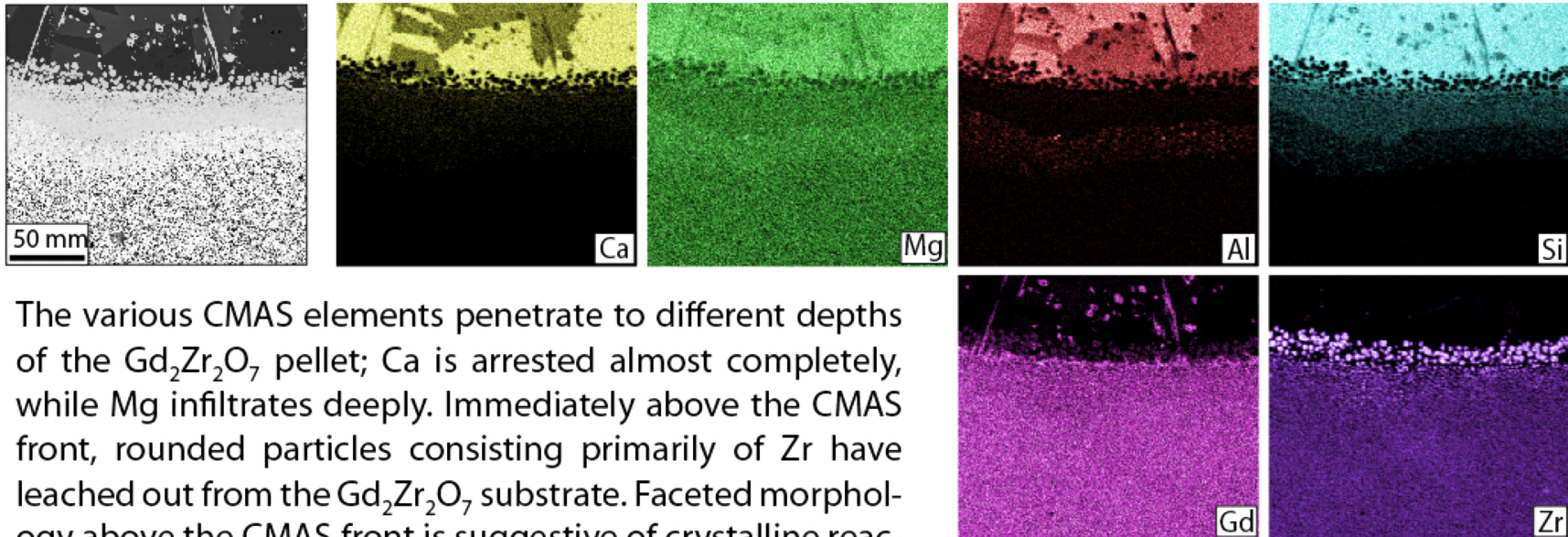

The various CMAS elements penetrate to different depths of the $Gd_2Zr_2O_7$ pellet; Ca is arrested almost completely, while Mg infiltrates deeply. Immediately above the CMAS front, rounded particles consisting primarily of Zr have leached out from the $Gd_2Zr_2O_7$ substrate. Faceted morphology above the CMAS front is suggestive of crystalline reaction products that consist mostly of Gd.



New Materials – Rapid Assessment of Thermo-Chemical Interactions

$GdYbZr_2O_7$

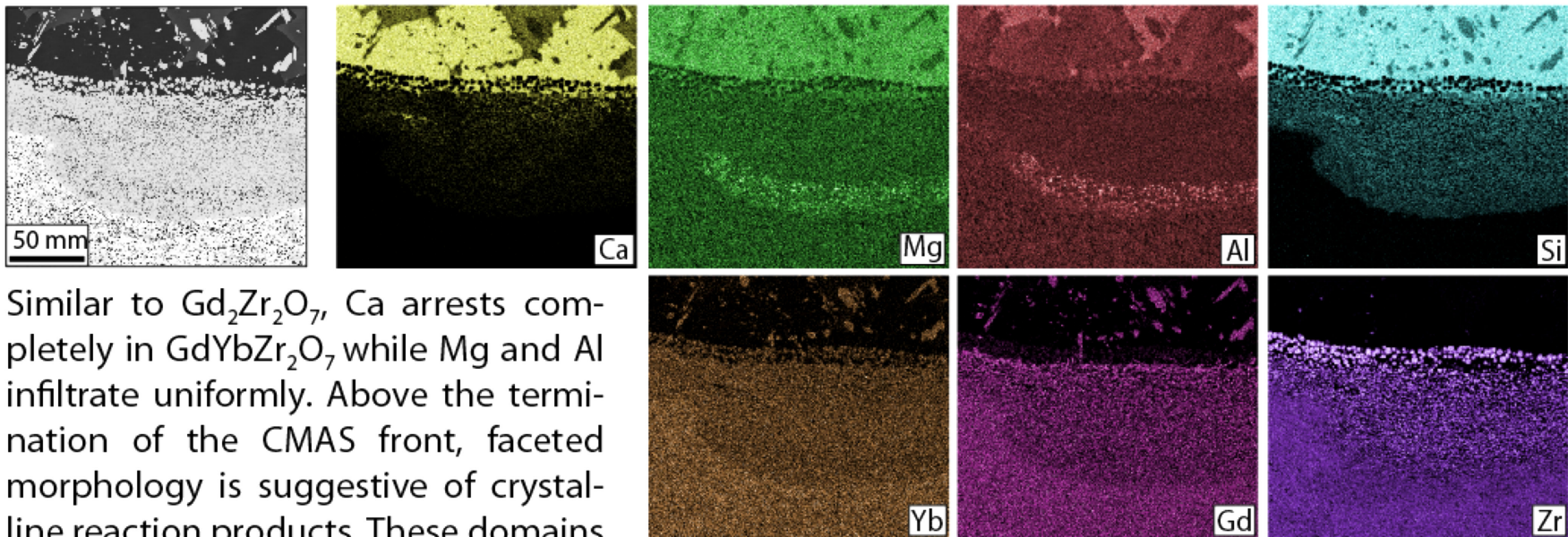

Similar to $Gd_2Zr_2O_7$, Ca arrests completely in $GdYbZr_2O_7$, while Mg and Al infiltrate uniformly. Above the termination of the CMAS front, faceted morphology is suggestive of crystalline reaction products. These domains consist mostly of Gd and Yb with little evidence of CMAS elements or Zr being incorporated.



New Materials – Free Standing TBC Materials (Zirconate)

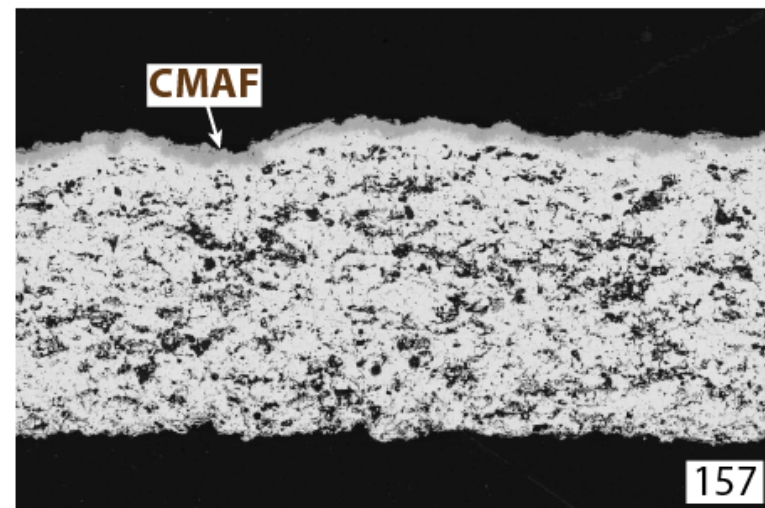
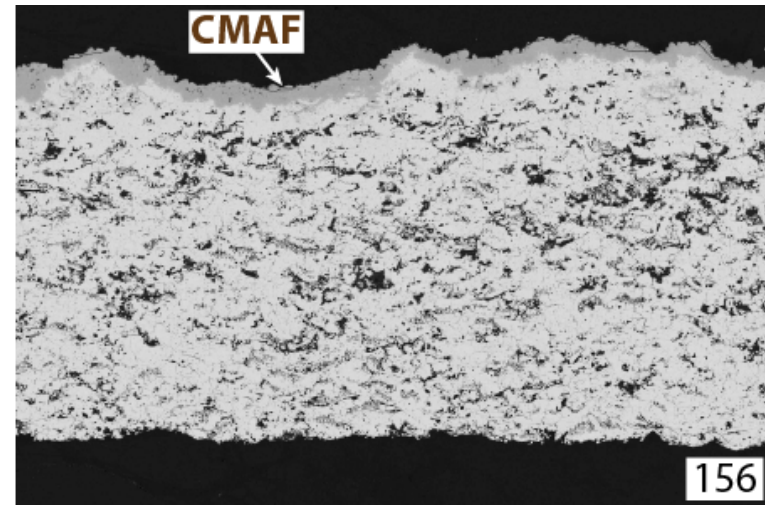
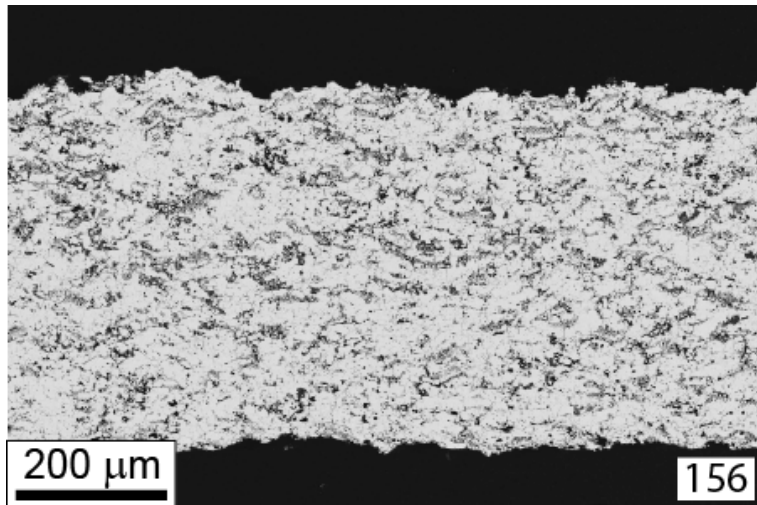

- -157 has larger pores than -156; CMAF does not penetrate too deeply into either sample



New Materials – TEC Determinations (Zirconate)

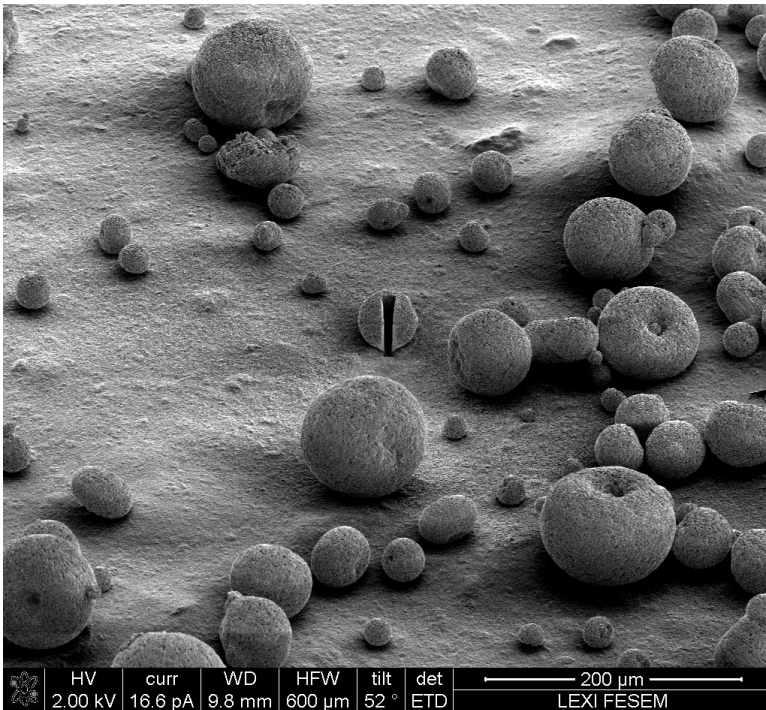

Alternative materials are being processed and basic material parameters determined as precursors for systematic stability studies.

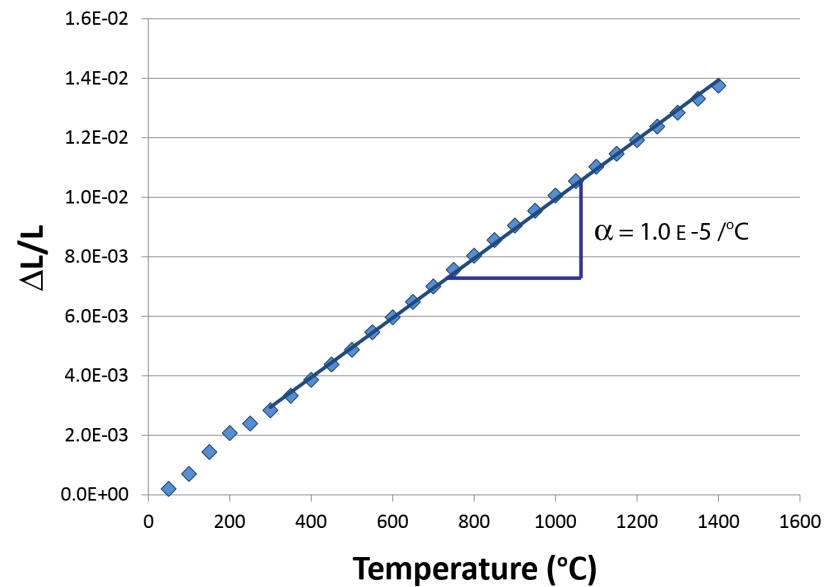
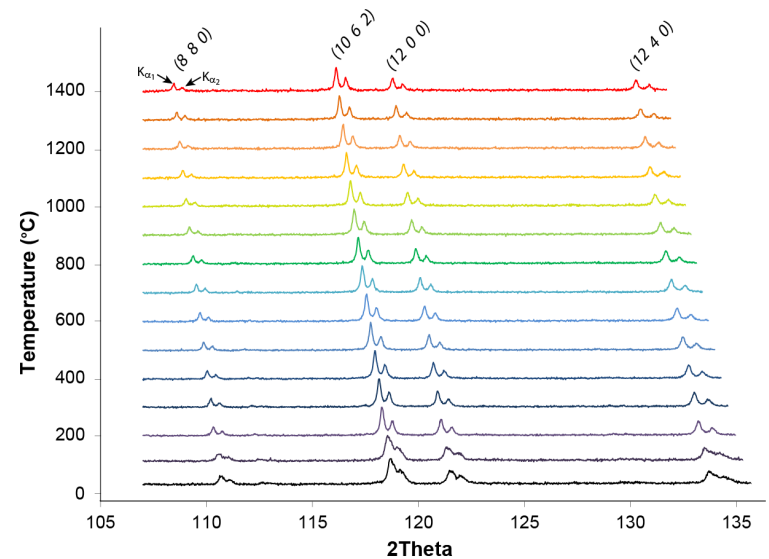

Summary: Accomplishments and Key Findings

- Investigated isolated effects of elevated water vapor levels on TGO formation, investigated in a manner intended to isolate *mechanisms* responsible for observed behavior. In BC systems that are not ‘borderline’ alloys for alumina formation, water vapor exposures do not lead directly to sustained spinel formation through enhanced Ni²⁺ ion transport along grain boundaries.
- Work with taper-polished geometries, combined with (S)TEM-based analysis, has shown that - for systems evaluated to date - spinel formation is not highly localized at through-thickness grain boundaries.
- However, a strong correlation between pH₂O and transient spinel formation is observed. Furthermore, there is a strong dependence of TGO growth kinetics on pH₂O, but volatilization effects counteract these effects and complicate analysis of mechanisms. Care must be taken during laboratory experimental procedures to avoid vapor-phase transport contributions to non-ideal oxide formation (irrelevant to TBC-coated materials degradation processes).
- Development of protective thermally grown oxides is highly dependent upon the relative partial pressures of combustion by products, and therefore varies with transitions to syngas-based systems. More work is needed to isolate mechanistic details and correlations with controllable materials design parameters.



Questions?

